

UNEF-UNS-UN...



UNEF UNS UN...

MASCHI A MACCHINA

MACHINE TAPS - TARAUDS MACHINE

UFS norm

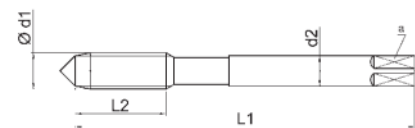

UFS norm

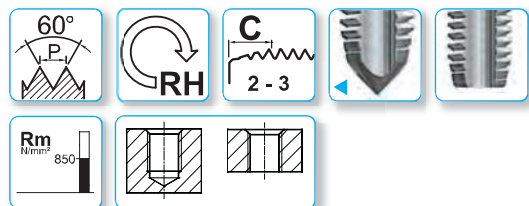
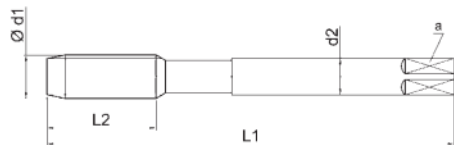

Profond. di filettatura - Thread depth - Profond. de filetage

1,5xD **1,5xD**

Materiale - Material - Matériau

HSSE **HSSE**

Tolleranza - Tolerance - Tolérance

2B **2B**

Trattamento superficiale - Surface treatment - Revêtement

BR **TiN**

Numero gruppi materiali
 Material's groups number
 Nombre de groupes du matériau

1.1 1.2 1.3 1.4 3.4 1.1 1.2 1.3 1.4 3.4

4.2 4.3 5.2 5.3 4.2 4.3 5.2 5.3

8.2 8.2

UFS norm	Ød1 UNEF	P TPI	Ø mm	L ₁	L ₂	d ₂ h9	a h12	Z	Z	
◀ 1/4	32	6,350	80	16	4,5	3,4	3	5,55		
◀ 5/16	32	7,938	90	18	6	4,9	3	7,15		
◀ 3/8	32	9,525	90	15	7	5,5	3	8,7		
7/16	28	11,113	100	20	8	6,2	3	10,2		
1/2	28	12,700	100	20	9	7	3	11,8		
9/16	24	14,288	100	22	11	9	4	13,2		
5/8	24	15,875	100	22	12	9	4	14,8		
11/16	24	17,462	110	25	14	11	4	16,4		
3/4	20	19,050	110	25	14	11	4	17,8		
13/16	20	20,638	125	25	16	12	4	19,4		
7/8	20	22,225	125	25	18	14,5	4	20,95		
1"	20	25,400	140	28	18	14,5	4	24,15		
1" 1/16	18	26,988	140	25	20	16	4	25,6		
1" 1/8	18	28,575	150	28	22	18	4	27,15		
1" 3/16	18	30,163	150	28	22	18	4	28,75		
1" 1/4	18	31,750	150	28	22	18	5	30,3		
1" 3/8	18	34,925	170	30	28	22	5	33,5		
1" 7/16	18	36,513	170	30	28	22	6	35,1		
1" 1/2	18	38,100	170	30	28	22	6	36,7		

		CODICE - CODE	
E21UNEF...		E21UNEF...T	
○		○	
○		○	
○		○	
○		○	
○		○	
○		○	
○		○	
○		○	
○		○	
○		○	
○		○	
○		○	
○		○	
○		○	
○		○	
○		○	
○		○	
○		○	
○		○	
○		○	
○		○	
○		○	
○		○	
○		○	
○		○	
○		○	
○		○	
○		○	
○		○	
○		○	
○		○	
○		○	
○		○	
○		○	
○		○	
○		○	
○		○	
○		○	
○		○	
○		○	
○		○	
○		○	
○		○	
○		○	
○		○	
○		○	
○		○	
○		○	
○		○	
○		○	
○		○	
○		○	
○		○	
○		○	
○		○	
○		○	

Confezione: Singola € Pag. listino - Price list - Liste des prix **89** **89**
 Box: Single
 Colis: Unique • Standard ○ Disponibilità da richiedere, prezzo a listino ★ Solo a richiesta
 On enquiry, standard price-list / Stock à vérifier Only on request / Sur demande

N **USO GENERALE**
 General purpose

MASCHI A MACCHINA
 MACHINE TAPS - TARAUDS MACHINE

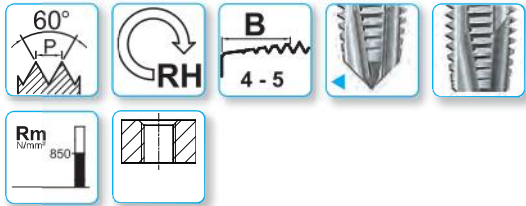
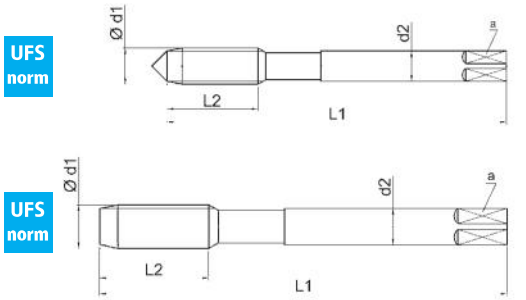

- Profond. di filettatura - Thread depth - Profond. de filetage
- Materiale - Material - Matériau
- Tolleranza - Tolerance - Tolérance
- Trattamento superficiale - Surface treatment - Revêtement

- 3xD
- HSSE
- 2B
- BR
- TiN

Numero gruppi materiali
 Material's groups number
 Nombre de groupes du matériau

- 1.1 1.2 1.3 1.4
- 4.1 4.2
- 5.1 5.2
- 1.1 1.2 1.3 1.4
- 3.3 3.4
- 4.1 4.2 4.3
- 5.1 5.2

UFS norm	Ød1 UNEF	P TPI	Ø mm	L ₁	L ₂	d ₂ h9	a h12	Z	Icon
◀	1/4	32	6,350	80	16	4,5	3,4	3	5,55
◀	5/16	32	7,938	90	18	6	4,9	3	7,15
◀	3/8	32	9,525	90	15	7	5,5	3	8,7
	7/16	28	11,113	100	20	8	6,2	3	10,2
	1/2	28	12,700	100	20	9	7	3	11,8
	9/16	24	14,288	100	22	11	9	4	13,2
	5/8	24	15,875	100	22	12	9	4	14,8
	11/16	24	17,462	110	25	14	11	4	16,4
	3/4	20	19,050	110	25	14	11	4	17,8
	13/16	20	20,638	125	25	16	12	4	19,4
	7/8	20	22,225	125	25	18	14,5	4	20,95
	1"	20	25,400	140	28	18	14,5	4	24,15
	1"1/16	18	26,988	140	25	20	16	4	25,6
	1"1/8	18	28,575	150	28	22	18	4	27,15
	1"3/16	18	30,163	150	28	22	18	4	28,75
	1"1/4	18	31,750	150	28	22	18	5	30,3
	1"3/8	18	34,925	170	30	28	22	5	33,5
	1"7/16	18	36,513	170	30	28	22	6	35,1
	1"1/2	18	38,100	170	30	28	22	6	36,7

CODICE - CODE	
E25UNEF...	E25UNEF...T
◊	◊
◊	◊
◊	◊
◊	◊
◊	◊
◊	◊
◊	◊
◊	◊
◊	◊
◊	◊
◊	◊
◊	◊
◊	◊
◊	◊
◊	◊
◊	◊
◊	◊
◊	◊
◊	◊
◊	◊
◊	◊
◊	◊
◊	◊
◊	◊
◊	◊
◊	◊
◊	◊
◊	◊

Confezione: Singola Box: Single Colis: Unique € Pag. listino - Price list - Liste des prix **89** **89**

● Standard ◊ Disponibilità da richiedere, prezzo a listino On enquiry, standard price-list / Stock à vérifier ★ Solo a richiesta Only on request / Sur demande

UNEF

MASCHI A MACCHINA

MACHINE TAPS - TARAUDS MACHINE

UFS norm

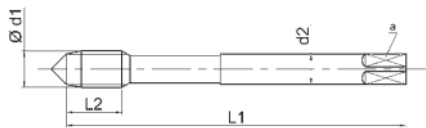

UFS norm

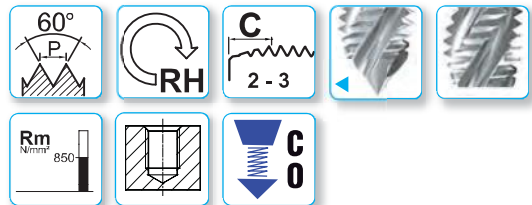
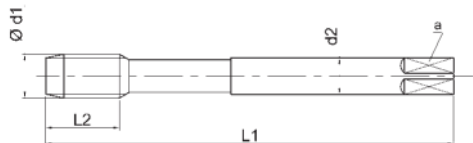

Profond. di filettatura - Thread depth - Profond. de filetage
Materiale - Material - Matériau
Tolleranza - Tolerance - Tolérance
Trattamento superficiale - Surface treatment - Revêtement

2,5xD	2,5xD
HSSE	HSSE
2B	2B
BR	XP
1.1 1.2 1.3 1.4	1.1 1.2 1.3 1.4
4.1 4.2	2.1 2.2 3.3 3.4
5.1 5.2	4.2 4.3
	5.2

Numero gruppi materiali
Material's groups number
Nombre de groupes du matériau

UFS norm	Ød1 UNEF	P TPI	Ø mm	L1	L2	d2 h9	a h12	Z	Image	CODICE - CODE	
										E61UNEF...	E61UNEF...XP
1/4	32	6,350	80	10	4,5	3,4	3	5,55	⊙	⊙	
5/16	32	7,938	90	13	6	4,9	3	7,15	⊙	⊙	
3/8	32	9,525	90	15	7	5,5	3	8,7	⊙	⊙	
7/16	28	11,113	100	15	8	6,2	3	10,2	⊙	⊙	
1/2	28	12,700	100	13	9	7	3	11,8	⊙	⊙	
9/16	24	14,288	100	15	11	9	4	13,2	⊙	⊙	
5/8	24	15,875	100	15	12	9	4	14,8	⊙	⊙	
11/16	24	17,462	110	17	14	11	4	16,4	⊙	⊙	
3/4	20	19,050	110	17	14	11	4	17,8	⊙	⊙	
13/16	20	20,638	125	18	16	12	4	19,4	⊙	⊙	
7/8	20	22,225	125	18	18	14,5	4	20,95	⊙	⊙	
1"	20	25,400	140	22	18	14,5	4	24,15	⊙	⊙	
1"1/16	18	26,988	140	20	20	16	4	25,6	⊙	⊙	
1"1/8	18	28,575	150	22	22	18	4	27,15	⊙	⊙	
1"3/16	18	30,163	150	22	22	18	4	28,75	⊙	⊙	
1"1/4	18	31,750	150	22	22	18	5	30,3	⊙	⊙	
1"3/8	18	34,925	170	24	28	22	5	33,5	⊙	⊙	
1"7/16	18	36,513	170	24	28	22	6	35,1	⊙	⊙	
1"1/2	18	38,100	170	24	28	22	6	36,7	⊙	⊙	

Confezione: Singola
Box: Single
Colis: Unique

€ Pag. listino - Price list - Liste des prix

89

89

● Standard

⊙ Disponibilità da richiedere, prezzo a listino
On enquiry, standard price-list / Stock à vérifier

★ Solo a richiesta
Only on request / Sur demande

N

USO GENERALE

General purpose - Usage Général

MASCHI A MACCHINA

MACHINE TAPS - TARAUDS MACHINE

UFS norm

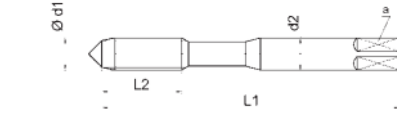

UFS norm

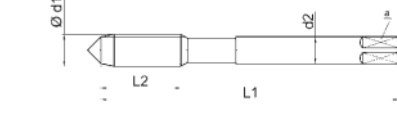

UFS norm

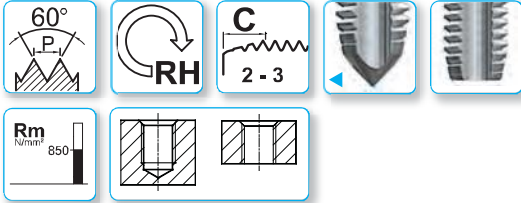
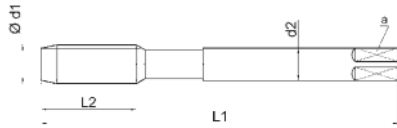

LINE



LINE



Profond. di filettatura - Thread depth - Profond. de filetage

Materiale - Material - Matériau

Tolleranza - Tolerance - Tolérance

Trattamento superficiale - Surface treatment - Revêtement

Numero gruppi materiali

Material's groups number

Nombre de groupes du matériau

1,5xD

1,5xD

HSSE

HSSE

2B

2B

BR

TiN

1.1 1.2 1.3 1.4 3.4

1.1 1.2 1.3 1.4 3.4

4.2 4.3 5.2 5.3

4.2 4.3 5.2 5.3

8.2

8.2

UFS norm	Ød1 UNS	P TPI	Ø mm	L ₁	L ₂	d ₂ h9	a h12	Z	
◀	10	40	4,826	70	13	6	4,9	3	4,2
◀	10	48	4,826	70	13	6	4,9	3	4,3
◀	12	36	5,486	80	16	6	4,9	3	4,8
◀	1/4	24	6,350	80	16	7	5,5	3	5,3
◀	1/4	36	6,350	80	16	7	5,5	3	5,6
◀	1/4	40	6,350	80	16	7	5,5	3	5,7

CODICE - CODE

E20-...UNS...

E20-...UNS...T

UFS norm	Ød1 UNS	P TPI	Ø mm	L ₁	L ₂	d ₂ h9	a h12	Z	
◀	5/16	40	7,938	90	18	6	4,9	3	7,3
◀	3/8	18	9,525	100	20	7	5,5	3	8,1
◀	3/8	27	9,525	90	15	7	5,5	3	8,6
◀	3/8	40	9,525	90	15	7	5,5	3	8,9
	7/16	24	11,113	100	20	8	6,2	3	10,05
	7/16	27	11,113	100	20	8	6,2	3	10,2
	1/2	24	12,700	100	20	9	7	3	11,6
	1/2	27	12,700	100	20	9	7	3	11,75
	5/8	27	15,875	100	22	12	9	4	14,9
	11/16	18	17,462	110	25	14	11	4	16,05
	3/4	18	19,050	110	25	14	11	4	17,6
	7/8	18	22,225	125	25	18	14,5	4	20,8
	7/8	24	22,225	125	25	18	14,5	4	21,2
	15/16	18	23,813	140	25	18	14,5	4	22,4
	1"	14	25,400	140	28	18	14,5	4	23,6
	1"	18	25,400	140	28	18	14,5	4	24
	1"	24	25,400	140	28	18	14,5	4	24,3
	1" 1/4	14	31,750	150	28	22	18	5	29,9
	1" 5/16	14	33,338	170	30	28	22	5	31,5

CODICE - CODE

E21-...UNS...

E21-...UNS...T

Confezione: Singola
Box: Single
Colis: Unique

€ Pag. listino - Price list - Liste des prix

90

90

● Standard

○ Disponibilità da richiedere, prezzo a listino
On enquiry, standard price-list / Stock à vérifier

★ Solo a richiesta
Only on request / Sur demande

UNS

8-UN
12-UN
16-UN

Filettatura americana UN ASME B1.1

UN thread ASME B1.1

Gewinde UN ASME B1.1 – Maschinengewindebohrer

Filetage UN ASME B1.1 – Tarauds machine

Rosca UN ASME B1.1 – Machos de roscar a máquina



N

USO GENERALE

General purpose - Usage Général

MASCHI A MACCHINA

MACHINE TAPS - TARAUDS MACHINE

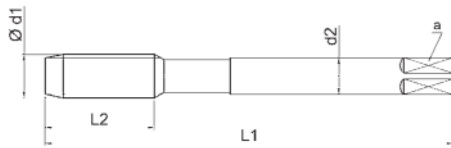

LINE

LINE

LINE

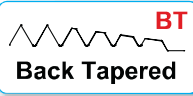
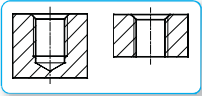

Profond. di filettatura - Thread depth - Profond. de filetage

Materiale - Material - Matériau

Tolleranza - Tolerance - Tolérance

Trattamento superficiale - Surface treatment - Revêtement

Numero gruppi materiali

Material's groups number

Nombre de groupes du matériau

1,5xD	1,5xD	2,5xD
HSSE	HSSE	HSSE
2B	2B	2B
BR	BR	BR
1.1 1.2 1.3 1.4 3.4	1.1 1.2 1.3 1.4 3.4	1.1 1.2 1.3 1.4 3.4
4.2 4.3 5.2 5.3	4.2 4.3 5.2 5.3	4.2 4.3 5.2 5.3
8.2	8.2	8.2

DIN 2184-1	Ød1	P	Ø	L ₁	L ₂	d ₂	a	Z	
8-UN	TPI	mm				h9	h12		
1"1/8	8	28,575	180	40	22	18	4	25,4	
1"1/4	8	31,750	180	40	22	18	4	28,6	
1"3/8	8	34,925	200	50	28	22	4	31,75	
1"1/2	8	38,100	200	50	28	22	4	34,9	
1"5/8	8	41,275	200	50	32	24	5	38,1	
1"3/4	8	44,450	200	50	36	29	5	41,3	
1"7/8	8	47,625	225	60	36	29	5	44,45	
2"	8	50,800	225	60	40	32	5	47,6	
2"1/4	8	57,150	250	65	45	35	6	54	
2"1/2	8	63,500	275	70	50	39	6	60,3	

CODICE - CODE		
E21-8UN...	E41-8UN...	E81-8UN...
○	○	○
○	○	○
○	○	○
○	○ (Z=5)	○ (Z=5)
○	○	○
○	○	○
○	○	○
○	○	○
○	○	○
○	○	○

RACCOMANDATO per filettatura rigida
We recommend Syncro rigid threading
Recommandé pour le taraudage rigide

UFS norm	Ød1	P	Ø	L ₁	L ₂	d ₂	a	Z	
12-UN	TPI	mm				h9	h12		
7/8	12	22,225	125	25	18	14,5	4	20,1	
1"1/16	12	26,988	140	25	20	16	4	24,9	
1"3/16	12	30,163	150	28	22	18	4	28	
1"5/16	12	33,338	170	30	28	22	5	31,2	
1"7/16	12	36,513	170	30	28	22	6	34,4	
1"5/8	12	41,275	170	30	32	24	6	39,2	
1"3/4	12	44,450	180	32	36	29	6	42,3	
2"	12	50,8	190	32	40	32	6	48,7	

CODICE - CODE		
E21-12UN...		
○		
○		
○		
○		
○		
○		
○		
○		
○		
○		

UFS norm	Ød1	P	Ø	L ₁	L ₂	d ₂	a	Z	
16-UN	TPI	mm				h9	h12		
1"	16	25,400	140	28	18	14,5	4	23,8	
1"1/8	16	28,575	150	28	22	18	5	30,15	
1"1/4	16	31,750	150	28	22	18	5	30,15	
1"1/2	16	38,100	170	30	28	22	6	36,5	
2"	16	50,8	190	32	40	32	6	49,2	

CODICE - CODE		
E21-16UN...		
○		
○		
○		
○		
○		

■ = Acciaio HSS / HSS Steel / Acier HSS

Confezione: Singola Box: Single Colis: Unique	€ Pag. listino - Price list - Liste des prix	91	91	91
	● Standard	○ Disponibilità da richiedere, prezzo a listino On enquiry, standard price-list / Stock à vérifier	★ Solo a richiesta Only on request / Sur demande	

N **USO GENERALE**
 General purpose - Usage Général

MASCHI A MACCHINA
 MACHINE TAPS - TARAUDS MACHINE

UFS norm

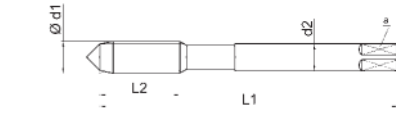

UFS norm

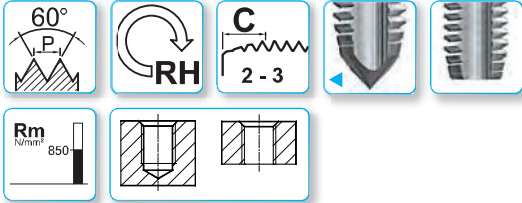
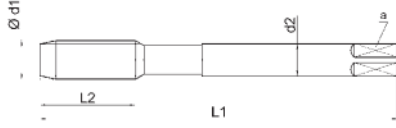

Profond. di filettatura - Thread depth - Profond. de filetage
 Materiale - Material - Matériau
 Tolleranza - Tolerance - Tolérance
 Trattamento superficiale - Surface treatment - Revêtement

1,5xD	1,5xD
HSSE	HSSE
2B	2B
BR	TiN
1.1 1.2 1.3 1.4 3.4	1.1 1.2 1.3 1.4 3.4
4.2 4.3 5.2 5.3	4.2 4.3 5.2 5.3
8.2	8.2

Numero gruppi materiali
 Material's groups number
 Nombre de groupes du matériau

UFS norm	Ød1	P	Ø	L ₁	L ₂	d ₂	a	Z	
	20-UN	TPI	mm			h9	h12		
◀	3/8	20	9,525	100	20	7	5,5	3	8,3
	5/8	20	15,875	100	22	12	9	4	14,6
	1" 1/16	20	26,988	140	25	20	16	4	25,7
	1" 1/8	20	28,575	150	28	22	18	4	27,3
	1" 1/4	20	31,750	150	28	22	18	5	30,5
	1" 3/8	20	34,925	170	30	28	22	5	33,7

CODICE - CODE	
E21-20UN...	E21-20UN...T
◊	◊
◊	◊
◊	◊
◊	◊
◊	◊
◊	◊

UFS norm	Ød1	P	Ø	L ₁	L ₂	d ₂	a	Z	
	28-UN	TPI	mm			h9	h12		
◀	3/8	28	9,525	90	15	7	5,5	3	8,6
	5/8	28	15,875	100	22	12	9	4	15

CODICE - CODE	
E21-28UN...	E21-28UN...T
◊	◊
◊	◊

UFS norm	Ød1	P	Ø	L ₁	L ₂	d ₂	a	Z	
	32-UN	TPI	mm			h9	h12		
	7/16	32	11,113	100	20	8	6,2	3	10,3
	1/2	32	12,700	100	20	9	7	3	11,9

CODICE - CODE	
E21-32UN...	E21-32UN...T
◊	◊
◊	◊

Confezione: Singola
 Box: Single
 Colis: Unique

€ Pag. listino - Price list - Liste des prix **91** **91**

● Standard ◊ Disponibilità da richiedere, prezzo a listino
 On enquiry, standard price-list / Stock à vérifier

★ Solo a richiesta
 Only on request / Sur demande

UN...

