

BSW-PG-Tr-Rd



BSW PG Tr Rd

N **USO GENERALE**
General purpose - Usage Général

MASCHI A MACCHINA
MACHINE TAPS - TARAUDS MACHINE

DIN 371

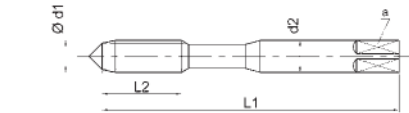

DIN 376

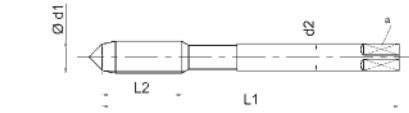

DIN 376

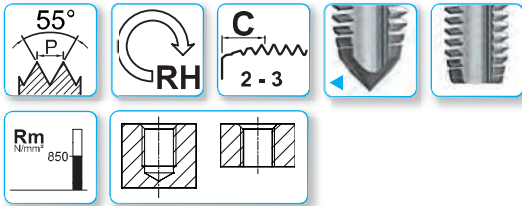

Profond. di filettatura - Thread depth - Profond. de filetage
Materiale - Material - Matériau
Tolleranza - Tolerance - Tolérance
Trattamento superficiale - Surface treatment - Revêtement

1,5xD **1,5xD**
HSSE **HSSE**
med. **med.**
BR **TiN**

Numero gruppi materiali
Material's groups number
Nombre de groupes du matériau

1.1 1.2 1.3 1.4 3.4
4.2 4.3 5.2 5.3
8.2

DIN 371	Ød1 BSW	P TPI	Ø mm	L ₁	L ₂	d ₂ h9	a h12	Z	
◀	1/8	40	3,175	56	10	3,5	2,7	3	2,5
◀	3/16	24	4,762	70	13	6	4,9	3	3,6
◀	1/4	20	6,350	80	16	7	5,5	3	5
◀	5/16	18	7,938	90	18	8	6,2	3	6,5
◀	3/8	16	9,525	100	20	10	8	3	7,9

CODICE - CODE	
E20W...	E20W...T
◊	◊
◊	◊
◊	◊
◊	◊
◊	◊

DIN 376	Ød1 BSW	P TPI	Ø mm	L ₁	L ₂	d ₂ h9	a h12	Z	
◀	5/16	18	7,938	90	18	6	4,9	3	6,5
◀	3/8	16	9,525	100	20	7	5,5	3	7,9
	7/16	14	11,113	100	20	8	6,2	3	9,2
	1/2	12	12,700	110	25	9	7	3	10,5
	9/16	12	14,288	110	28	11	9	3	12
	5/8	11	15,876	110	28	12	9	3	13,4
	3/4	10	19,051	125	32	14	11	4	16,4
	7/8	9	22,226	140	32	18	14,5	4	19,25
	1"	8	25,401	160	36	18	14,5	4	22
	1"1/8	7	28,576	180	46	22	18	4	24,75
	1"1/4	7	31,751	180	46	22	18	4	27,5
	1"3/8	6	34,926	200	50	28	22	4	30,5
	1"1/2	6	38,101	200	50	28	22	4	33,5

CODICE - CODE	
E21W...	E21W...T
◊	◊
◊	◊
◊	◊
◊	◊
◊	◊
◊	◊
◊	◊
◊	◊
◊	◊
◊	◊
◊	◊
◊	◊
◊	◊
◊	◊
◊	◊

Confezione / Box / Colis: 1/8 - 7/16: 10 pezzi / pcs; 1/2 - 5/8: 5 pezzi / pcs; >5/8: singoli / single pcs

€ Pag. listino - Price list - Liste des prix **101** **101**

● Standard ◊ Disponibilità da richiedere, prezzo a listino On enquiry, standard price-list / Stock à vérifier ★ Solo a richiesta Only on request / Sur demande

N

USO GENERALE

General purpose - Usage Général

MASCHI A MACCHINA

MACHINE TAPS - TARAUDS MACHINE

DIN 371

DIN 371

DIN 376

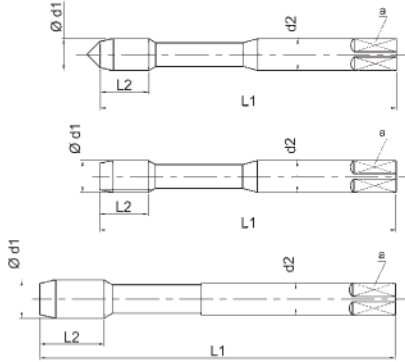

LINE

LINE

LINE

LINE



R40°

R40°

R40°

R40°

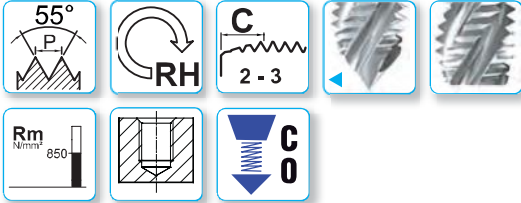

Profond. di filettatura - Thread depth - Profond. de filetage

Materiale - Material - Matériau

Tolleranza - Tolerance - Tolérance

Trattamento superficiale - Surface treatment - Revêtement

Numero gruppi materiali

Material's groups number

Nombre de groupes du matériau

2,5xD

2,5xD

2,5xD

2,5xD

HSSE

HSSE

HSSE

HSSE

med.

med.

med.

med.

BR

V

TiN

XP

1.1 1.2 1.3 1.4

1.1 1.2 1.3 1.4

1.1 1.2 1.3 1.4

1.1 1.2 1.3 1.4

4.1 4.2

4.1 4.2

3.3 3.4

2.1 2.2 3.3 3.4

5.1 5.2

5.1 5.2

4.1 4.2 4.3

4.2 4.3

5.1 5.2

5.2

DIN 371	Ød1 BSW	P TPI	Ø mm	L ₁	L ₂	d ₂ h9	a h12	Z	
◀	1/8	40	3,175	56	5	3,5	2,7	3	2,5
◀	3/16	24	4,762	70	8	6	4,9	3	3,6
◀	1/4	20	6,350	80	10	7	5,5	3	5
	5/16	18	7,938	90	13	8	6,2	3	6,5
	3/8	16	9,525	100	15	10	8	3	7,9

E60W...	CODICE - CODE		
	E60W...V	E60W...T	E60W...XP
○	○	○	○
○	○	○	○
○	○	○	○
○	○	○	○
○	○	○	○

DIN 376	Ød1 BSW	P TPI	Ø mm	L ₁	L ₂	d ₂ h9	a h12	Z	
	5/16	18	7,938	90	13	6	4,9	3	6,5
	3/8	16	9,525	100	15	7	5,5	3	7,9
	7/16	14	11,113	100	15	8	6,2	3	9,2
	1/2	12	12,700	110	18	9	7	3	10,5
	9/16	12	14,288	110	20	11	9	4	12
	5/8	11	15,876	110	20	12	9	4	13,4
	3/4	10	19,051	125	25	14	11	4	16,4
	7/8	9	22,226	140	25	18	14,5	4	19,25
	1"	8	25,401	160	30	18	14,5	4	22
	1"1/8	7	28,576	180	35	22	18	4	24,75
	1"1/4	7	31,751	180	35	22	18	4	27,5
	1"3/8	6	34,926	200	40	28	22	4	30,5
	1"1/2	6	38,101	200	40	28	22	4	33,5

E61W...	CODICE - CODE		
	E61W...V	E61W...T	E61W...XP
○	○	○	○
○	○	○	○
○	○	○	○
○	○	○	○
○	○	○	○
○	○	○	○
○	○	○	○
○	○	○	○
○	○	○	○
○	○	○	○
○	○	○	○
○	○	○	○
○	○	○	○
○	○	○	○

Confezione / Box / Colis:
1/8 - 7/16: 10 pezzi / pcs
1/2 - 5/8: 5 pezzi / pcs
>5/8: singoli / single pcs

€ Pag. listino - Price list - Liste des prix

102

102

102

102

● Standard

○ Disponibilità da richiedere, prezzo a listino
On enquiry, standard price-list / Stock à vérifier

★ Solo a richiesta
Only on request / Sur demande

MASCHI A FILETTATURA TONDA

ROUND THREAD TAPS - TARAUD AVEC FILETS RONDS

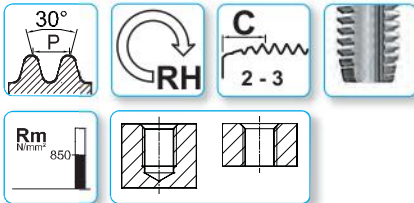
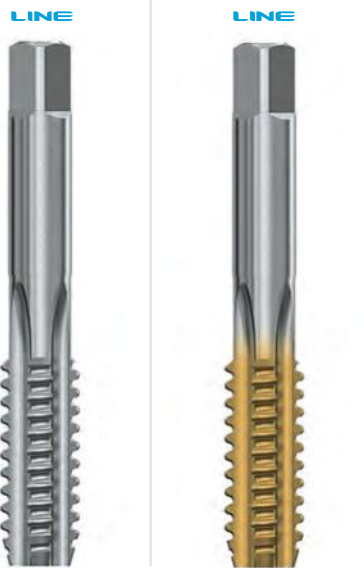
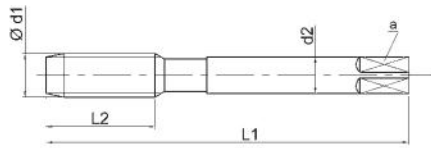

Profond. di filettatura - Thread depth - Profond. de filetage

Materiale - Material - Matériau

Tolleranza - Tolerance - Tolérance

Trattamento superficiale - Surface treatment - Revêtement

1xD

1xD

HSSE

HSSE

7H

7H

BR

TiN

Numero gruppi materiali

Material's groups number

Nombre de groupes du matériau

1.1 1.2 1.3 1.4

1.1 1.2 1.3 1.4

4.1 4.2

3.1 3.2 3.3 3.4

5.1 5.2

4.2 4.3 4.4

5.2 5.3

Ød1 Rd	P TPI	L ₁	L ₂	d ₂ h9	a ₂ h12	Z	
8	10	70	22	8	6,2	3	6
9	10	70	22	8	6,2	3	7
10	10	70	22	8	6,2	3	8
11	10	70	22	8	6,2	3	9
12	10	75	25	9	7	3	10
14	8	80	26	11	9	3	11,5
16	8	80	27	12	9	3	13,5
18	8	95	32	14	11	4	15,5
20	8	95	32	16	12	4	17,5
22	8	100	32	18	14,5	4	19,5
24	8	110	36	18	14,5	4	21,5
26	8	110	36	20	16	4	23,5
28	8	125	34	22	18	4	25,5
30	8	125	34	22	18	4	27,5

CODICE - CODE

E21RD...

E21RD...T

*

*

*

*

*

*

*

*

*

*

*

*

*

*

*

*

*

*

*

*

*

*

*

*

Altri diametri disponibili a richiesta.
Other diameters available on request.
Autres diamètres disponibles sur demande.

A richiesta:
Filettatura tonda per il settore minerario DIN 20400
Filettatura tonda per il settore del trasporto su rotaia DIN 264

On request:
Round thread for mining industries DIN 20400
Round thread for rail vehicles DIN 264

Sur demande:
Filetage rond selon DIN 20400

Confezione: Singola
Box: Single
Colis: Unique

€ Pag. listino - Price list - Liste des prix

104

104

● Standard

▷ Disponibilità da richiedere, prezzo a listino
On enquiry, standard price-list / Stock à vérifier

★ Solo a richiesta
Only on request / Sur demande