

MF

MF



MASCHI A MANO

HAND TAPS - TARAUDS MAIN

DIN 2181

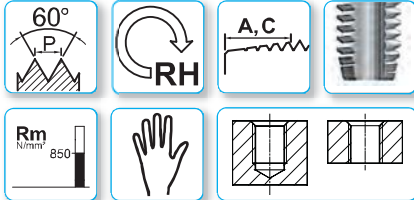
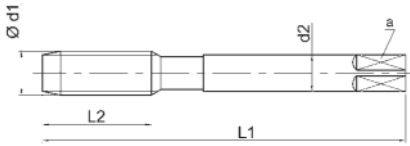

LINE

LINE

LINE



Profond. di filettatura - Thread depth - Profond. de filetage

Materiale - Material - Matériau

Tolleranza - Tolerance - Tolérance

Trattamento superficiale - Surface treatment - Revêtement

Numero gruppi materiali
Material's groups number
Nombre de groupes du matériau

2xD

2xD

2xD

HSS

HSS

HSS

-

ISO2/6H

ISO2/6H

BR

BR

BR

1.1 1.2 1.3 1.4

1.1 1.2 1.3 1.4

1.1 1.2 1.3 1.4

2.1 2.2 2.3 3.1 3.4

2.1 2.2 2.3 3.1 3.4

2.1 2.2 2.3 3.1 3.4

4.1 4.2 4.3 4.4

4.1 4.2 4.3 4.4

4.1 4.2 4.3 4.4

5.1 5.2 5.3

5.1 5.2 5.3

5.1 5.2 5.3

DIN 2181	Ød1 MF	P mm	L ₁	L ₂	d ₂ h9	a h12	Z	
	38	1,5	100	25	28	22	6	36,5
	39	1,5	110	25	32	24	6	37,5
	39	2	125	36	32	24	4	37
	39	3	125	36	32	24	4	36
	40	1,5	110	25	32	24	6	38,5
	40	2	125	36	32	24	5	38
	40	3	125	36	32	24	5	37
	42	1,5	110	25	32	24	6	40,5
	42	2	125	36	32	24	5	40
	42	3	125	36	32	24	5	39
	45	1,5	110	25	36	29	6	43,5
	45	2	125	36	36	29	5	43
	45	3	125	36	36	29	5	42
	48	1,5	140	36	36	29	6	46,5
	48	2	140	36	36	29	6	46
	48	3	140	36	36	29	6	45
	50	1,5	140	36	36	29	6	48,5
	50	2	140	36	36	29	6	48
	50	3	140	36	36	29	6	47
	52	1,5	140	36	40	32	6	50,5
	52	2	140	36	40	32	6	50
	52	3	140	36	40	32	6	49

CODICE - CODE

01MF...

03MF...

00MF...

*

o

o

*

o

o

*

o

o

*

o

o

*

o

o

*

o

o

*

o

o

*

o

o

*

o

o

*

o

o

*

o

o

*

o

o

*

o

o

*

o

o

*

o

o

*

o

o

*

o

o

*

o

o

*

o

o



Ad esaurimento scorte
Stock clearance - Stock épuisé

Confezione: Singola
Box: Single
Colis: Unique

€ Pag. listino - Price list - Liste des prix

44

44

44

● Standard

▷ Disponibilità da richiedere, prezzo a listino
On enquiry, standard price-list / Stock à vérifier

★ Solo a richiesta
Only on request / Sur demande

N USO GENERALE
General purpose - Usage Général

MASCHI A MANO, FILETTATURA SINISTRA
LEFT HAND TAPS - TARAUDS MAIN GAUCHE

DIN 2181

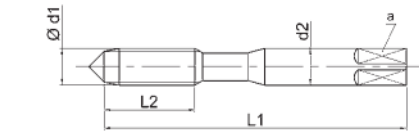

DIN 2181

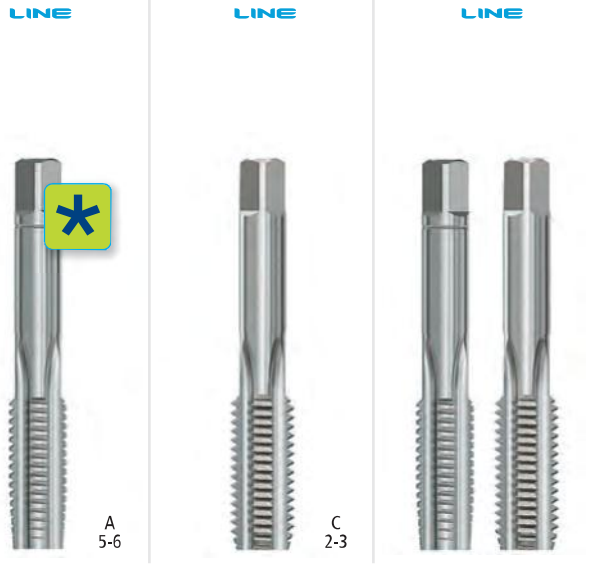
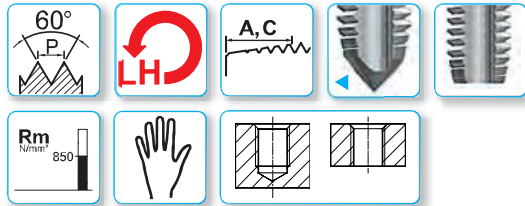
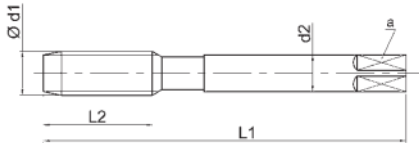

MF

Profond. di filettatura - Thread depth - Profond. de filetage
Materiale - Material - Matériau
Tolleranza - Tolerance - Tolérance
Trattamento superficiale - Surface treatment - Revêtement

2xD	2xD	2xD
HSS	HSS	HSS
-	ISO2/6H	ISO2/6H
BR	BR	BR

Numero gruppi materiali
Material's groups number
Nombre de groupes du matériau

1.1 1.2 1.3 1.4	1.1 1.2 1.3 1.4	1.1 1.2 1.3 1.4
2.1 2.2 2.3 3.1 3.4	2.1 2.2 2.3 3.1 3.4	2.1 2.2 2.3 3.1 3.4
4.1 4.2 4.3 4.4	4.1 4.2 4.3 4.4	4.1 4.2 4.3 4.4
5.1 5.2 5.3	5.1 5.2 5.3	5.1 5.2 5.3

DIN 2181	Ød1 MF	P mm	L ₁	L ₂	d ₂ h9	a h12	Z	
◀	4	0,5	45	11	4,5	3,4	3	3,5
◀	5	0,5	50	13	6	4,9	3	4,5
◀	6	0,75	56	15	6	4,9	3	5,25
	8	1	63	19	6	4,9	3	7
	10	1,25	70	22	7	5,5	3	8,75
	10	1	63	20	7	5,5	3	9
	11	1	63	20	8	6,2	3	10
	12	1,5	70	22	9	7	4	10,5
	12	1,25	70	22	9	7	4	10,75
	12	1	70	22	9	7	4	11
	14	1,5	70	22	11	9	4	12,5
	16	1,5	70	22	12	9	4	14,5
	18	1,5	80	22	14	11	4	16,5
	20	1,5	80	22	16	12	4	18,5

CODICE - CODE	01MF...LH			03MF...LH			00MF...LH		
	◊			◊			◊		
	◊			◊			◊		
	◊			◊			◊		
	◊			◊			●		
	◊			◊			●		
	◊			◊			●		
	◊			◊			◊		
	◊			◊			◊		
	◊			◊			◊		
	◊			◊			●		
	◊			◊			●		
	◊			◊			◊		
	◊			◊			●		

★ Ad esaurimento scorte
Stock clearance - Stock épuisé

Confezione: Singola Box: Single Colis: Unique	€ Pag. listino - Price list - Liste des prix	44	44	44
	● Standard	◊ Disponibilità da richiedere, prezzo a listino On enquiry, standard price-list / Stock à vérifier	★ Solo a richiesta Only on request / Sur demande	

MASCHI A MACCHINA

MACHINE TAPS - TARAUDS MACHINE

MF

DIN 371

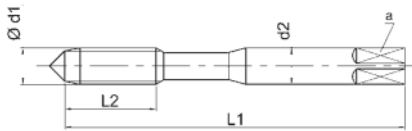

DIN 371

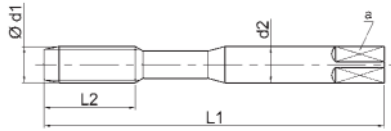

LINE



LINE

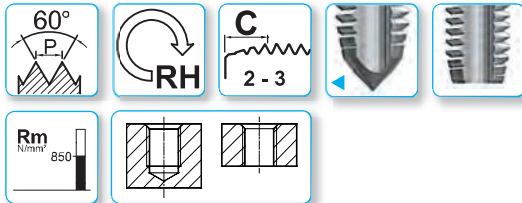

Profond. di filettatura - Thread depth - Profond. de filetage

Materiale - Material - Matériau

Tolleranza - Tolerance - Tolérance

Trattamento superficiale - Surface treatment - Revêtement

1,5xD

1,5xD

HSSE

HSSE

ISO2/6H

ISO2/6H

BR

TiN

Numero gruppi materiali

Material's groups number

Nombre de groupes du matériau

1.1	1.2	1.3	1.4	3.4	1.1	1.2	1.3	1.4	3.4
4.2	4.3	5.2	5.3	4.2	4.3	5.2	5.3		
8.2					8.2				

DIN 371	Ød1 MF	P mm	L1	L2	d2 h9	a h12	Z	
◀	4	0,5	63	13	4,5	3,4	3	3,5
◀	5	0,5	70	13	6	4,9	3	4,5
◀	6	0,5	80	16	6	4,9	3	5,5
◀	6	0,75	80	16	6	4,9	3	5,25
◀	7	0,75	80	16	7	5,5	3	6,25
◀	8	0,5	90	18	8	6,2	3	7,5
◀	8	0,75	90	18	8	6,2	3	7,25
◀	8	1	90	18	8	6,2	3	7
	9	0,5	90	18	9	7	3	8,5
	9	0,75	90	18	9	7	3	8,25
	9	1	90	18	9	7	3	8
◀	10	0,5	90	15	10	8	3	9,5
◀	10	0,75	90	15	10	8	3	9,25
◀	10	1	90	15	10	8	3	9
◀	10	1,25	100	20	10	8	3	8,75

CODICE - CODE	
E20MF...	E20MF...T
○	○
○	○
○	○
●	○
○	○
○	○
○	○
●	○
★	★
★	★
○	○
○	○
○	○
●	○
●	○

Segue diametri / Diameters, to be continued ▶ Pag. 87...92

MASCHI A MACCHINA

MACHINE TAPS - TARAUDS MACHINE

DIN 374

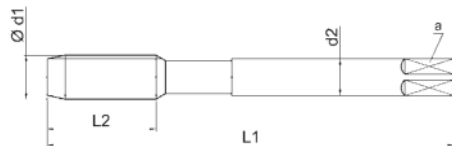

LINE

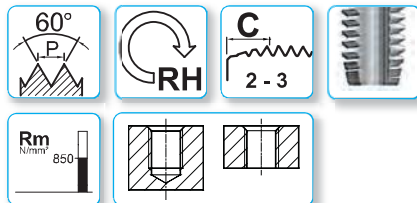

Profond. di filettatura - Thread depth - Profond. de filetage

1,5xD

Materiale - Material - Matériau

HSSE

Tolleranza - Tolerance - Tolérance

ISO2/6H

Trattamento superficiale - Surface treatment - Revêtement

BR

Numero gruppi materiali

Material's groups number

Nombre de groupes du matériau

1.1 1.2 1.3 1.4 3.4

4.2 4.3 5.2 5.3

8.2

DIN 374	Ød1 MF	P mm	L ₁	L ₂	d ₂ h9	a h12	Z	
	36	1	170	30	28	22	5	35
	36	1,25	170	30	28	22	5	34,75
	36	1,5	170	30	28	22	5	34,5
	36	2	170	30	28	22	5	34
	36	3	200	50	28	22	4	33
	37	1	170	30	28	22	6	36
	37	1,5	170	30	28	22	6	35,5
	38	1	170	30	28	22	6	37
	38	1,5	170	30	28	22	6	36,5
	38	2	170	30	28	22	6	36
	38	3	200	50	28	22	4	35
	39	1	170	30	32	24	6	38
	39	1,5	170	30	32	24	6	37,5
	39	2	170	30	32	24	6	37
	39	3	200	50	32	24	4	36
	40	1	170	30	32	24	6	39
	40	1,5	170	30	32	24	6	38,5
	40	2	170	30	32	24	6	38
	40	3	200	50	32	24	5	37
	42	1	170	30	32	24	6	41
	42	1,5	170	30	32	24	6	40,5
	42	2	170	30	32	24	6	40
	42	3	200	55	32	24	5	39
	45	1	180	32	36	29	6	44
	45	1,5	180	32	36	29	6	43,5
	45	2	180	32	36	29	6	43
	45	3	200	50	36	29	5	42

■ = Acciaio HSS / HSS Steel / Acier HSS

CODICE - CODE

E21MF...

○

○

○

○

○

○

○

○

○

○

○

○

○

○

○

○

○

○

○

○

○

○

Segue diametri
Diameters, to be continued
Diamètres à suivre

Pag. 91...92

Confezione: Singola
Box: Single
Colis: Unique

€ Pag. listino - Price list - Liste des prix

45

● Standard

○ Disponibilità da richiedere, prezzo a listino
On enquiry, standard price-list / Stock à vérifier

★ Solo a richiesta
Only on request / Sur demande

MASCHI A MACCHINA

MACHINE TAPS - TARAUDS MACHINE

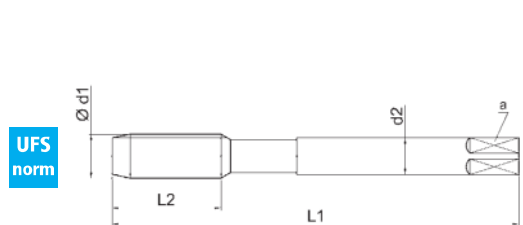

LINE

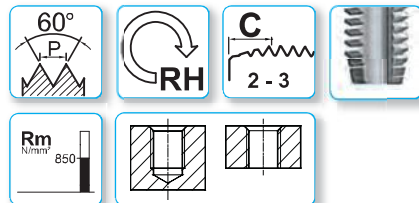

Profond. di filettatura - Thread depth - Profond. de filetage

1,5xD

Materiale - Material - Matériau

HSSE

Tolleranza - Tolerance - Tolérance

ISO2/6H

Trattamento superficiale - Surface treatment - Revêtement

BR

Numero gruppi materiali

Material's groups number

Nombre de groupes du matériau

1.1 1.2 1.3 1.4 3.4

4.2 4.3 5.2 5.3

8.2

UFS norm	Ød1 MF	P mm	L ₁	L ₂	d ₂ h9	a h12	Z	
■	*60	1,5	190	32	45	35	6	58,5
■	*60	2	190	32	45	35	6	58
■	*60	3	220	65	45	35	6	57
■	*60	4	220	65	45	35	6	56
■	*62	1,5	190	32	50	39	6	60,5
■	*62	2	190	32	50	39	6	60
■	*63	1,5	190	32	50	39	6	61,5
■	*64	1,5	190	32	50	39	6	62,5
■	*64	2	190	32	50	39	6	62
■	*64	3	220	65	50	39	6	61
■	*64	4	220	65	50	39	6	60

CODICE - CODE

E21MF...

■ = Acciaio HSS / HSS Steel / Acier HSS

* Dimensioni a norma UFS / Dimensions according UFS' norms / Dimensions selon norme UFS

Confezione: Singola
Box: Single
Colis: Unique

€ Pag. listino - Price list - Liste des prix

46

● Standard

○ Disponibilità da richiedere, prezzo a listino
On enquiry, standard price-list / Stock à vérifier

★ Solo a richiesta
Only on request / Sur demande

MASCHI A MACCHINA

MACHINE TAPS - TARAUDS MACHINE

MF

DIN 371

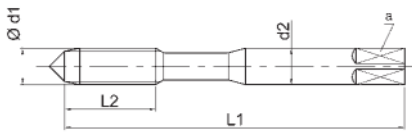

DIN 371

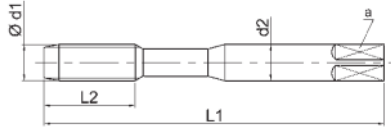

LINE



LINE



LINE



Profond. di filettatura - Thread depth - Profond. de filetage

Materiale - Material - Matériau

Tolleranza - Tolerance - Tolérance

Trattamento superficiale - Surface treatment - Revêtement

Al Si > 10%,
 Ottone / Brass / Laiton
 Bronzo / Bronze / Bronze
 truciolo corto / short chip /
 coupeaux courts

Numero gruppi materiali
 Material's groups number
 Nombre de groupes du matériau

3xD	3xD	3,5xD
HSSE	HSSE	HSSE
6HX	6HX	6HX
NQ	TiCN	TiCN
3.1 3.2 3.3 3.4 3.5	3.1 3.2 3.3 3.4 3.5	3.1 3.2 3.3 3.4 3.5
4.3 4.4 4.5 4.6 5.3	4.3 4.4 4.5 4.6 5.3	4.3 4.4 4.5 4.6 5.3
8.2 10.1	8.2 10.1	8.2 10.1

DIN 371	Ød1 MF	P mm	L1	L2	d2 h9	a h12	Z	
4	0,5	63	13	4,5	3,4	3	3,5	
5	0,5	70	13	6	4,9	3	4,5	
6	0,75	80	16	6	4,9	3	5,25	
8	1	90	18	8	6,2	4	7	
10	1	90	15	10	8	4	9	
10	1,25	100	20	10	8	4	8,75	
6	0,75	80	16	6	4,9	3	5,25	
8	1	90	18	8	6,2	4	7	
10	1	90	15	10	8	4	9	
10	1,25	100	20	10	8	4	8,75	

CODICE - CODE		
E26MF...NQ	E26MF...CT	
-	○	
-	○	
-	○	
○	●	
○	○	
○	●	
E26MF...SP-NQ	E26MF...SP-CT	E26MF...FOR-CT
★	★	★
○	○	○
○	○	○
○	○	○

Confezione / Box / Collis: M3 – M10: 10 pezzi / pcs M12 – M16: 5 pezzi / pcs	€ Pag. listino - Price list - Liste des prix	46	46	46
● Standard	○ Disponibilità da richiedere, prezzo a listino On enquiry, standard price-list / Stock à vérifier	○	★ Solo a richiesta Only on request / Sur demande	○

HR

ALTA RESISTENZA

High Resistance - Haute Résistance

MASCHI A MACCHINA

MACHINE TAPS - TARAUDS MACHINE

DIN 371

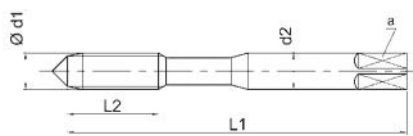

DIN 374

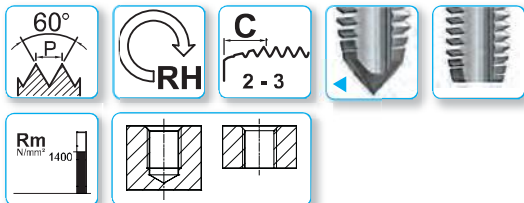
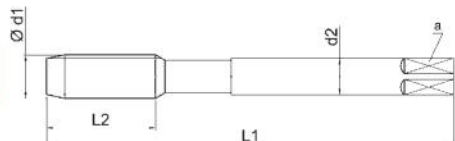

Profond. di filettatura - Thread depth - Profond. de filetage
 Materiale - Material - Matériau
 Tolleranza - Tolerance - Tolérance
 Trattamento superficiale - Surface treatment - Revêtement

Ghisa / Cast iron / Fonte
 Al Si > 10%
 Ottone / Brass / Laiton
 Bronzo / Bronze / Bronze
 truciolo corto / short chip / coupeaux courts

Numero gruppi materiali
 Material's groups number
 Nombre de groupes du matériau

2xD	3,5xD	3,5xD	3,5xD
PM3	PM3	PM3	MDI-HM
6HX	ISO2/6H	ISO2/6H	6HX
TXC	TXC	TXC	BR
1.5 1.6	1.3 1.4 1.5 1.6	1.3 1.4 1.5 1.6	3.1 3.2 3.3 3.4 3.5
4.3 4.4 4.5 4.6 5.3 5.4	3.1 3.2 3.3 3.4 3.5	3.1 3.2 3.3 3.4 3.5	4.3 4.4 4.5 4.6
8.2 8.3 10.1	4.3 4.4 4.5 4.6 5.3 5.4	4.3 4.4 4.5 4.6 5.3 5.4	5.3 5.4 8.2 8.3
	8.2 8.3 10.1	8.2 8.3 10.1	10.1

DIN 371	Ød1 MF	P mm	L ₁	L ₂	d ₂ h9	a h12	Z	
	8	1	90	18	8	6,2	-	7
	10	1	100	20	10	8	-	9
	10	1,25	100	20	10	8	-	8,75

CODICE - CODE		*HM20MF...FOR
		*
		*
		*

DIN 374	Ød1 MF	P mm	L ₁	L ₂	d ₂ h9	a h12	Z	
	8	1	90	18	6	4,9	4	7
	10	1	90	15	7	5,5	4	9
	10	1,25	100	20	7	5,5	4	8,75
	12	1,25	100	22	9	7	4	10,75
	12	1,5	100	22	9	7	4	10,5
	14	1,5	100	22	11	9	4	12,5
	16	1,5	100	22	12	9	4	14,5
	12	1,5	100	22	9	7	3	10,5
	14	1,5	100	22	11	9	3	12,5
	16	1,5	100	22	12	9	3	14,5
	18	1,5	110	25	14	11	3	16,5
	20	1,5	125	25	16	12	3	18,5
	22	1,5	125	25	18	14,5	3	20,5
	24	1,5	140	25	18	14,5	4	22,5

CODICE - CODE		*HM21MF...FOR
K21MF...TXC		-
○		-
○		-
○		*
○		*
○		*
○		*
	K23MF...FOR-TXC	K23MF...FOR-TXC
	○	○
	○	○
	○	○
	○	○
	○	○
	○	○

*A richiesta rivestimento:
 On request coating:
 Sur demande revêtement:
TiCN

Confezione / Box / Colis: M3 – M12: 5 pezzi / pcs >M12: singoli / single pcs	€ Pag. listino - Price list - Liste des prix	48	49	49	49
	● Standard	○ Disponibilità da richiedere, prezzo a listino On enquiry, standard price-list / Stock à vérifier	★ Solo a richiesta Only on request / Sur demande		

MF Filettatura metrica ISO passo fine DIN 13

ISO metric fine thread DIN13
 Metrisches ISO-Feingewinde DIN 13 – Maschinengewindebohrer
 Filetage métrique ISO à pas fin DIN 13 – Tarauds machine
 Rosca ISO métrica fina DIN 13 – Machos de rosca a máquina



N **USO GENERALE**
 General purpose - Usage Général

MASCHI A MACCHINA

MACHINE TAPS - TARAUDS MACHINE

DIN 371

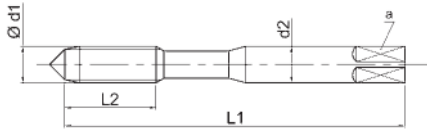

DIN 371

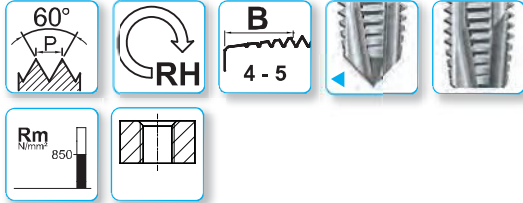
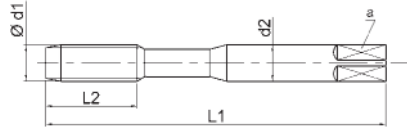

Profond. di filettatura - Thread depth - Profond. de filetage	3xD	3xD	3xD	3xD
Materiale - Material - Matériau	HSSE	HSSE	HSSE	HSSE
Tolleranza - Tolerance - Tolérance	ISO2/6H	ISO2/6H	ISO2/6H	ISO2/6H
Trattamento superficiale - Surface treatment - Revêtement	BR	V	TiN	TXC
Numero gruppi materiali Material's groups number Nombre de groupes du matériau	1.1 1.2 1.3 1.4	1.1 1.2 1.3 1.4	1.1 1.2 1.3 1.4	1.1 1.2 1.3 1.4
	4.1 4.2	4.1 4.2	3.3 3.4	2.1 2.2 3.3 3.4
	5.1 5.2	5.1 5.2	4.1 4.2 4.3	4.2 4.3

DIN 371	Ød1 MF	P mm	L1	L2	d2 h9	a h12	Z	
◀	4	0,5	63	13	4,5	3,4	3	3,5
◀	5	0,5	70	13	6	4,9	3	4,5
◀	6	0,75	80	16	6	4,9	3	5,25
◀	7	0,75	80	16	7	5,5	3	6,25
◀	8	0,75	90	18	8	6,2	3	7,25
◀	8	1	90	18	8	6,2	3	7
◀	9	1	90	18	9	7	3	8
◀	10	0,75	90	15	10	8	3	9,25
◀	10	1	90	15	10	8	3	9
◀	10	1,25	100	20	10	8	3	8,75

E24MF...	CODICE - CODE			E24MF...TXC
	E24MF...V	E24MF...T		
○	○	○	○	
○	○	○	○	
○	○	○	○	
○	○	○	○	
○	○	○	○	
●	●	○	○	
○	○	○	○	
○	○	○	○	
●	●	○	○	
●	●	○	○	

Segue diametri
 Diameters, to be continued
 Diamètres à suivre

Confezione / Box / Colis: M3 – M10: 10 pezzi / pcs M12 – M16: 5 pezzi / pcs	€ Pag. listino - Price list - Liste des prix	49	49	49	49
● Standard	○ Disponibilità da richiedere, prezzo a listino On enquiry, standard price-list / Stock à vérifier	★ Solo a richiesta Only on request / Sur demande			

N **USO GENERALE**
 General purpose - Usage Général

MASCHI A MACCHINA
 MACHINE TAPS - TARAUDS MACHINE

DIN 374

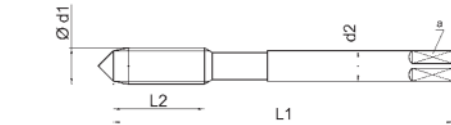

DIN 374

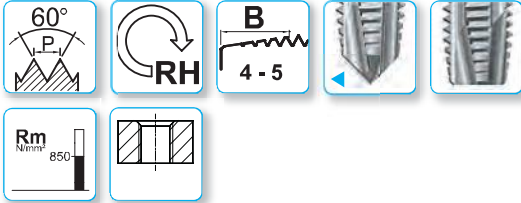
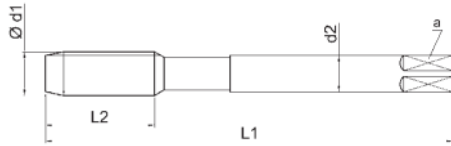

MF

Profond. di filettatura - Thread depth - Profond. de filetage
 Materiale - Material - Matériau
 Tolleranza - Tolerance - Tolérance
 Trattamento superficiale - Surface treatment - Revêtement

3xD	3xD	3xD	3xD
HSSE	HSSE	HSSE	HSSE
ISO2/6H	ISO2/6H	ISO2/6H	ISO2/6H
BR	V	TiN	TXC

Numero gruppi materiali
 Material's groups number
 Nombre de groupes du matériau

1.1 1.2 1.3 1.4	1.1 1.2 1.3 1.4	1.1 1.2 1.3 1.4	1.1 1.2 1.3 1.4
4.1 4.2	4.1 4.2	3.3 3.4	2.1 2.2 3.3 3.4
5.1 5.2	5.1 5.2	4.1 4.2 4.3	4.2 4.3
	6.1 7.1	5.1 5.2	5.2

DIN 374	Ød1 MF	P mm	L ₁	L ₂	d ₂ h9	a h12	Z	
◀	6	0,75	80	16	4,5	3,4	3	5,25
◀	8	1	90	18	6	4,9	3	7
◀	10	1	90	15	7	5,5	3	9
◀	10	1,25	100	20	7	5,5	3	8,75
	12	1	100	22	9	7	3	11
	12	1,25	100	22	9	7	3	10,75
	12	1,5	100	22	9	7	3	10,5
	14	1	100	22	11	9	4	13
	14	1,25	100	22	11	9	4	12,75
	14	1,5	100	22	11	9	4	12,5
	16	1	100	22	12	9	4	15
	16	1,5	100	22	12	9	4	14,5
	18	1	110	25	14	11	4	17
	18	1,5	110	25	14	11	4	16,5
	20	1	125	25	16	12	4	19
	20	1,5	125	25	16	12	4	18,5
	22	1	125	25	18	14,5	4	21
	22	1,5	125	25	18	14,5	4	20,5
	24	1	140	25	18	14,5	4	23
	24	1,5	140	25	18	14,5	4	22,5
	24	2	140	25	18	14,5	4	22
	25	1,5	140	25	18	14,5	4	23,5
	25	2	140	25	18	14,5	4	23
	26	1,5	140	25	18	14,5	4	24,5
	26	2	140	25	18	14,5	4	24

E25MF...	CODICE - CODE		
	E25MF...V	E25MF...T	E25MF...TXC
◊	◊	◊	◊
●	◊	◊	◊
◊	◊	◊	◊
●	◊	◊	◊
◊	◊	◊	◊
●	●	●	◊
●	●	●	◊
◊	◊	◊	◊
◊	◊	◊	◊
●	●	●	◊
◊	◊	◊	◊
◊	◊	◊	◊
◊	◊	◊	◊
◊	◊	◊	◊
●	◊	◊	◊
◊	◊	◊	◊

Segue diametri
 Diameters, to be continued
 Diamètres à suivre

▶ Pag. 102...103

Confezione / Box / Colis: M3 – M10: 10 pezzi / pcs M12 – M16: 5 pezzi / pcs	€ Pag. listino - Price list - Liste des prix	50	50	51	51
	● Standard	○ Disponibilità da richiedere, prezzo a listino On enquiry, standard price-list / Stock à vérifier		★ Solo a richiesta Only on request / Sur demande	

MF Filettatura metrica ISO passo fine DIN 13

ISO metric fine thread DIN13
 Metrisches ISO-Feingewinde DIN 13 – Maschinengewindebohrer
 Filetage métrique ISO à pas fin DIN 13 – Tarauds machine
 Rosca ISO métrica fina DIN 13 – Machos de roscar a máquina



N

USO GENERALE
 General purpose - Usage Général

MASCHI A MACCHINA, FILETTATURA SINISTRA

LEFT THREAD MACHINE TAPS - TARAUDS MACHINE GAUCHE

MF

DIN 371

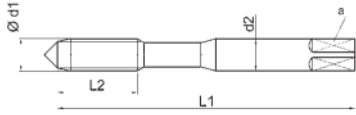

DIN 374

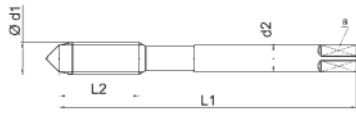

DIN 374

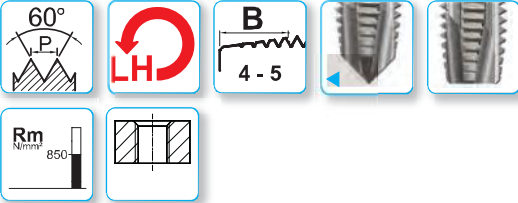
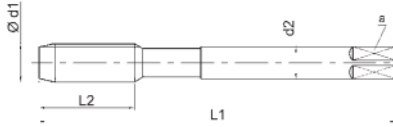

LINE



LINE



Profond. di filettatura - Thread depth - Profond. de filetage

3xD 3xD

Materiale - Material - Matériau

HSSE HSSE

Tolleranza - Tolerance - Tolérance

6H 6H

Trattamento superficiale - Surface treatment - Revêtement

BR **TiN**

Numero gruppi materiali
 Material's groups number
 Nombre de groupes du matériau

1.1	1.2	1.3	1.4	1.1	1.2	1.3	1.4
4.1	4.2			3.3	3.4		
5.1	5.2			4.1	4.2	4.3	
				5.1	5.2		

DIN 371	Ød1 MF	P mm	L ₁	L ₂	d ₂ h9	a h12	Z	
◀	8	1	90	18	8	6,2	3	7
◀	10	1	90	15	10	8	3	9
◀	10	1,25	100	20	10	8	3	8,75

CODICE - CODE			
E24MF...LH	E24MF...LH-T		
○	○		
○	○		
○	○		

DIN 374	Ød1 MF	P mm	L ₁	L ₂	d ₂ h9	a h12	Z	
◀	8	1	90	18	6	4,9	3	7
◀	10	1	90	15	7	5,5	3	9
◀	10	1,25	100	20	7	5,5	3	8,75
	12	1,25	100	22	9	7	3	10,75
	12	1,5	100	22	9	7	3	10,5
	14	1,5	100	22	11	9	4	12,5
	16	1,5	100	22	12	9	4	14,5

CODICE - CODE			
E25MF...LH	E25MF...LH-T		
○	○		
○	○		
○	○		
○	○		
○	○		
○	○		
○	○		

Confezione / Box / Colis: M3 – M10: 10 pezzi / pcs M12 – M16: 5 pezzi / pcs	€ Pag. listino - Price list - Liste des prix ● Standard	52	52	★ Solo a richiesta Only on request / Sur demande
---	--	----	----	---

N **USO GENERALE**
General purpose - Usage Général

MASCHI A MACCHINA
MACHINE TAPS - TARAUDS MACHINE

DIN 371

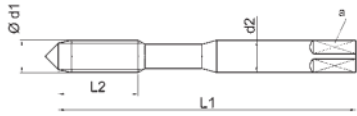

DIN 374

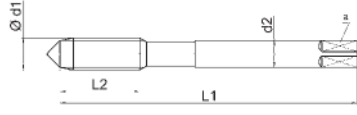

DIN 374

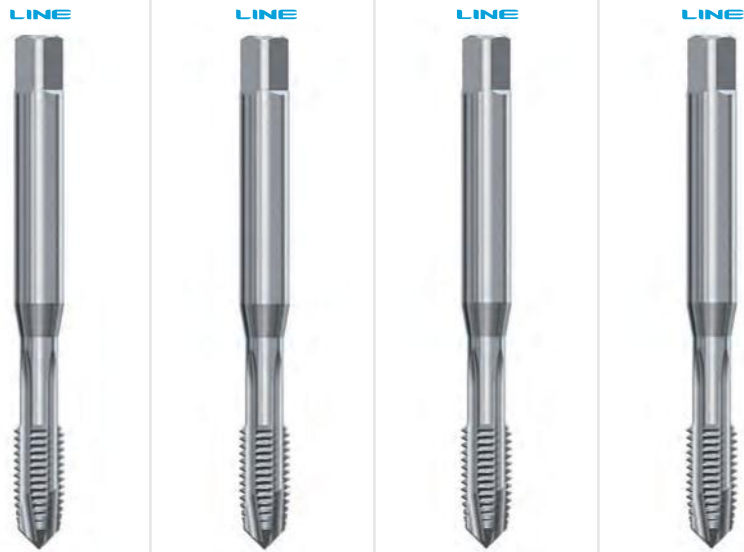
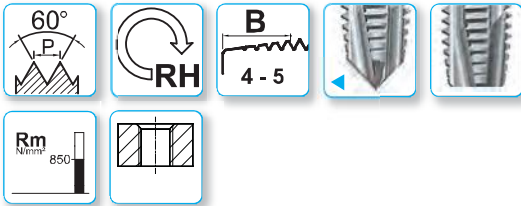
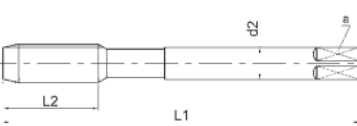

Profond. di filettatura - Thread depth - Profond. de filetage

Materiale - Material - Matériau

Tolleranza - Tolerance - Tolérance

Trattamento superficiale - Surface treatment - Revêtement

Numero gruppi materiali
Material's groups number
Nombre de groupes du matériau

3xD	3xD	3xD	3xD
HSSE	HSSE	HSSE	HSSE
ISO1/4H	ISO3/6G	7G(6H+0,05)	6H+0,1
BR	BR	BR	BR
1.1 1.2 1.3 1.4	1.1 1.2 1.3 1.4	1.1 1.2 1.3 1.4	1.1 1.2 1.3 1.4
4.1 4.2	4.1 4.2	4.1 4.2	4.1 4.2
5.1 5.2	5.1 5.2	5.1 5.2	5.1 5.2

DIN 371	Ød1 MF	P mm	L ₁	L ₂	d ₂ h9	a h12	Z	
◀	8	1	90	18	8	6,2	3	7
◀	10	1	90	15	10	8	3	9
◀	10	1,25	100	20	10	8	3	8,75

CODICE - CODE			
E24MF...-4H	E24MF...-6G	E24MF...-7G	E24MF...+0,1
*	*	*	*
*	*	*	*
*	*	*	*

DIN 374	Ød1 MF	P mm	L ₁	L ₂	d ₂ h9	a h12	Z	
◀	8	1	90	18	6	4,9	3	7
◀	10	1	90	15	7	5,5	3	9
◀	10	1,25	100	20	7	5,5	3	8,75
	12	1,25	100	22	9	7	3	10,75
	12	1,5	100	22	9	7	3	10,5
	14	1,5	100	22	11	9	4	12,5
	16	1,5	100	22	12	9	4	14,5

CODICE - CODE			
E25MF...-4H	E25MF...-6G	E25MF...-7G	E25MF...+0,1
○	●	○	○
○	●	○	○
○	●	○	○
○	●	○	○
○	●	○	○
○	●	○	○
○	●	○	○

Confezione / Box / Colis: M3 – M10: 10 pezzi / pcs M12 – M16: 5 pezzi / pcs	€ Pag. listino - Price list - Liste des prix	52	52	52	52
	● Standard	○ Disponibilità da richiedere, prezzo a listino On enquiry, standard price-list / Stock à vérifier		★ Solo a richiesta Only on request / Sur demande	

N USO GENERALE R ≤ 1000N/mm²
General purpose R ≤ 1000N/mm² - Usage Général R ≤ 1000N/mm²

MASCHI A MACCHINA
MACHINE TAPS - TARAUDS MACHINE

DIN 374

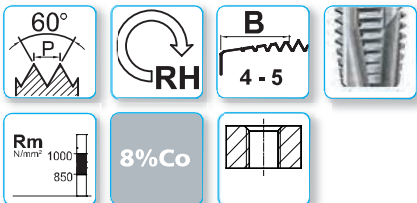
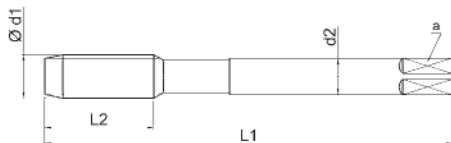

Profond. di filettatura - Thread depth - Profond. de filetage
Materiale - Material - Matériau
Tolleranza - Tolerance - Tolérance
Trattamento superficiale - Surface treatment - Revêtement

3xD	3xD	3xD	3xD
HSSP	HSSP	HSSP	HSSP
6H	6H	6H	6H
BR	V	TiN	TiCN

Numero gruppi materiali
Material's groups number
Nombre de groupes du matériau

1.1 1.2 1.3 1.4	1.1 1.2 1.3 1.4	1.1 1.2 1.3 1.4 1.5	1.1 1.2 1.3 1.4 1.5
4.1 4.2	4.1 4.2	3.3 3.4 4.1 4.2 4.3	2.1 2.2
5.1 5.2	5.1 5.2	5.1 5.2	3.3 3.4 4.2 4.3
	6.1 7.1		5.2

DIN 374	Ød1 MF	P mm	L ₁	L ₂	d ₂ h9	a h12	Z	
8	1	90	18	6	4,9	3	7	
10	1	90	15	7	5,5	3	9	
10	1,25	100	20	7	5,5	3	8,75	
12	1,25	100	22	9	7	4	10,75	
12	1,5	100	22	9	7	4	10,5	
14	1,5	100	22	11	9	4	12,5	
16	1,5	100	22	12	9	4	14,5	
18	1,5	110	25	14	11	4	16,5	
20	1,5	125	25	16	12	4	18,5	

P25MF...	CODICE - CODE			P25MF...CT
	P25MF...V	P25MF...T		
○	○	○	○	
○	○	○	○	
○	○	○	○	
○	○	○	○	
○	○	○	○	
*	*	*	*	
*	*	*	*	
*	*	*	*	
*	*	*	*	

★ Solo a richiesta
Only on request / Sur demande

Confezione / Box / Colis: M3 – M10: 10 pezzi / pcs M12 – M16: 5 pezzi / pcs	€ Pag. listino - Price list - Liste des prix	53	53	53	53
	● Standard	○ Disponibilità da richiedere, prezzo a listino On enquiry, standard price-list / Stock à vérifier			

Ti **TITANIO**
Titanium - Titane

MASCHI A MACCHINA
MACHINE TAPS - TARAUDS MACHINE

DIN 371

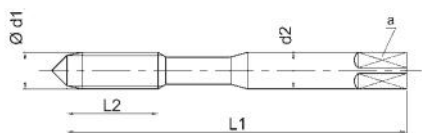

DIN 374

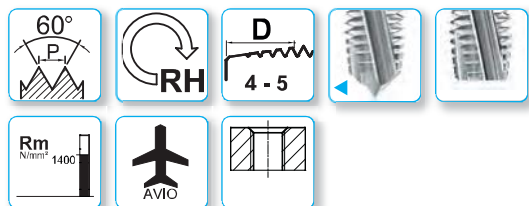
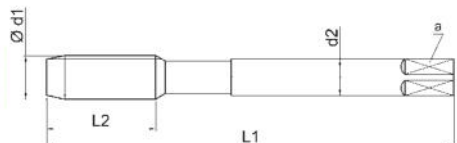

Profond. di filettatura - Thread depth - Profond. de filetage
 Materiale - Material - Matériau
 Tolleranza - Tolerance - Tolérance
 Trattamento superficiale - Surface treatment - Revêtement

Numero gruppi materiali
 Material's groups number
 Nombre de groupes du matériau

L15°	L15°	L15°
3xD	3xD	3xD
PM3	PM3	PM3
6HX	6HX	4H
V	TiCN	V
6.1	1.6 2.4	6.1
	3.3 3.4	
	4.4 5.3 5.4 6.2 6.3	
	7.2 9.2	



DIN 371	Ød1 MF	P mm	L ₁	L ₂	d ₂ h9	a h12	Z	
◀	8	1	90	18	8	6,2	3	*7
◀	10	1	100	20	10	8	3	*9
◀	10	1,25	100	20	10	8	3	*8,75

CODICE - CODE		
K52MF...V	K52MF...CT	*K52MJF...V
○	○	○
○	○	○
○	○	○

DIN 374	Ød1 MF	P mm	L ₁	L ₂	d ₂ h9	a h12	Z	
	12	1,25	100	22	9	7	3	*10,75
	12	1,5	100	22	9	7	3	*10,5
	14	1,5	100	22	11	9	3	*12,5
	16	1,5	100	22	12	9	3	*14,5

CODICE - CODE		
K53MF...V	K53MF...CT	*K53MJF...V
○	○	○
○	○	○
○	○	○
○	○	○

* Per MJ vedi tabella di foratura pag. 252
 * Drills' diameters for MJ: table page 252
 * Pour MJ voir le tableau de perçage page 252

* Rivestimento TiCN a richiesta
 * TiCN coating on request
 * Revêtement TiCN sur demande

Confezione / Box / Colis: M3 – M10: 10 pezzi / pcs M12 – M16: 5 pezzi / pcs	€ Pag. listino - Price list - Liste des prix	55	56	56
● Standard	○ Disponibilità da richiedere, prezzo a listino On enquiry, standard price-list / Stock à vérifier			★ Solo a richiesta Only on request / Sur demande

MF Filettatura metrica ISO passo fine DIN 13

ISO metric fine thread DIN13
 Metrisches ISO-Feingewinde DIN 13 – Maschinengewindebohrer
 Filetage métrique ISO à pas fin DIN 13 – Tarauds machine
 Rosca ISO métrica fina DIN 13 – Machos de roscar a máquina



Ni

NICHEL
 Nickel - Nickel

MASCHI A MACCHINA

MACHINE TAPS - TARAUDS MACHINE

UFS norm

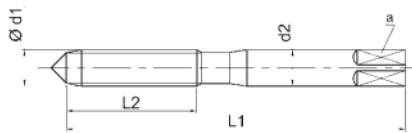

UFS norm

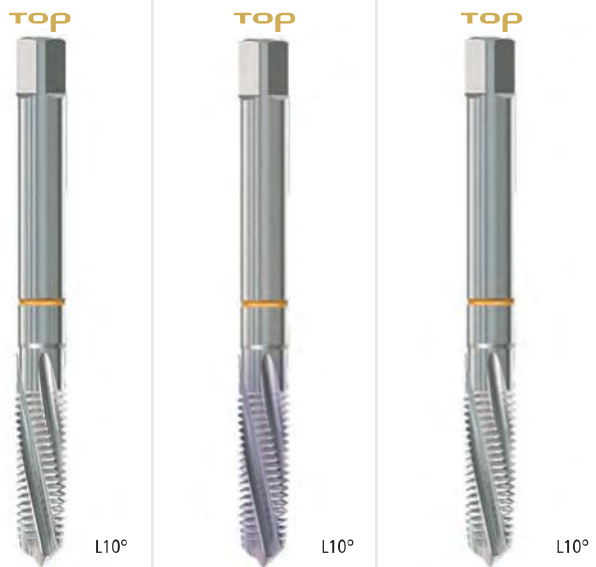
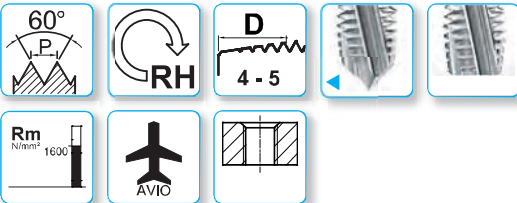
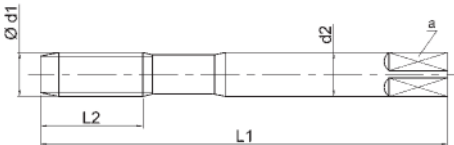

Profond. di filettatura - Thread depth - Profond. de filetage
 Materiale - Material - Matériau
 Tolleranza - Tolerance - Tolérance
 Trattamento superficiale - Surface treatment - Revêtement

3xD	3xD	3xD
PM3	PM3	PM3
6HX	6HX	4HX
BR	TiCN	BR
7.3 9.3	1.6 5.4	7.3 9.3
	7.2 9.1	

Numero gruppi materiali
 Material's groups number
 Nombre de groupes du matériau

UFS norm	Ød1 MF	P mm	L ₁	L ₂	d ₂ h9	a h12	Z	
◀	8	1	90	25	8	6,2	3	*7
◀	10	1	100	30	10	8	3	*9
◀	10	1,25	100	30	10	8	3	*8,75
	12	1,25	110	30	12	9	3	*10,75
	12	1,5	110	30	12	9	3	*10,5
	14	1,5	110	30	12	9	3	*12,5
	16	1,5	110	30	16	12	3	*12,5

K52MF...NI	CODICE - CODE	
	K52MF...NI-CT	K52MF...NI-4HX
○	○	★
○	○	★
○	○	★
○	○	★
○	○	★
○	○	★
○	○	★

* Per MJ vedi tabella di foratura pag. 252
 * Drills' diameters for MJ: table page 252
 * Pour MJ voir le tableau de perçage page 252

Confezione / Box / Colis: M3 – M10: 10 pezzi / pcs M12 – M16: 5 pezzi / pcs	€ Pag. listino - Price list - Liste des prix	56	56	56
● Standard	○ Disponibilità da richiedere, prezzo a listino On enquiry, standard price-list / Stock à vérifier	○	○	★ Solo a richiesta Only on request / Sur demande

N USO GENERALE
General purpose - Usage Général

MASCHI A MACCHINA
MACHINE TAPS - TARAUDS MACHINE

DIN 371

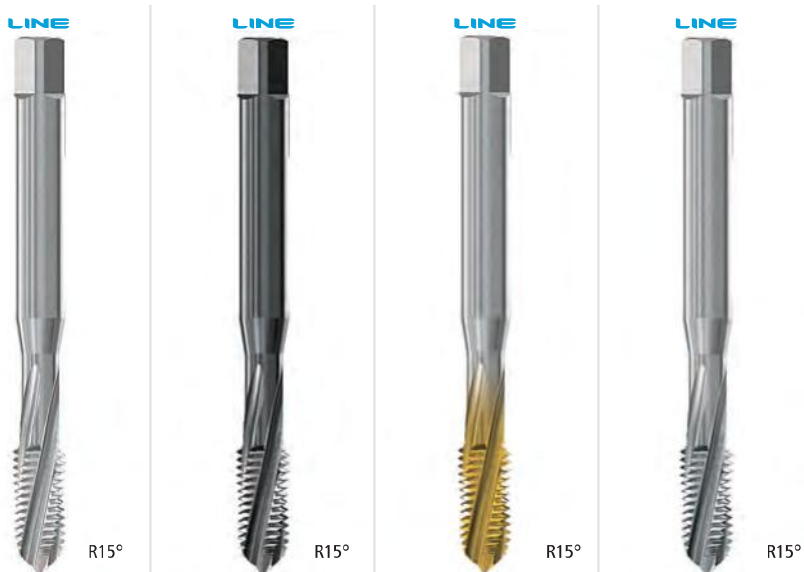
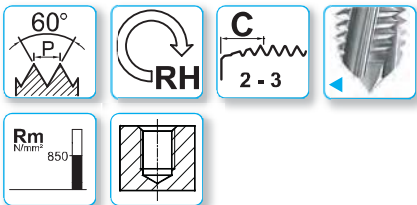
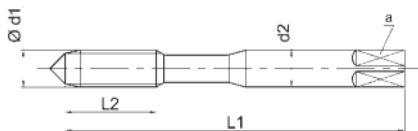

Profond. di filettatura - Thread depth - Profond. de filetage

Materiale - Material - Matériau

Tolleranza - Tolerance - Tolérance

Trattamento superficiale - Surface treatment - Revêtement

Numero gruppi materiali
Material's groups number
Nombre de groupes du matériau

1,5xD	1,5xD	1,5xD	1,5xD
HSSE	HSSE	HSSE	HSSE
ISO2/6H	ISO2/6H	ISO2/6H	ISO2/6H
BR	V	TiN	XP
1.1 1.2 1.3 1.4	1.1 1.2 1.3 1.4	1.1 1.2 1.3 1.4	1.1 1.2 1.3 1.4
4.1 4.2	4.1 4.2	3.3 3.4	3.3 3.4
5.1 5.2	5.1 5.2	4.1 4.2 4.3	4.2 4.3
	6.1 7.1	5.1 5.2	5.2

DIN 371	Ød1 MF	P mm	L ₁	L ₂	d ₂ h9	a h12	Z	
◀	4	0,5	63	13	4,5	3,4	3	3,5
◀	5	0,5	70	13	6	4,9	3	4,5
◀	6	0,75	80	16	6	4,9	3	5,25
◀	8	0,75	90	18	8	6,2	3	7,25
◀	8	1	90	18	8	6,2	3	7
◀	10	1	90	15	10	8	3	9
◀	10	1,25	100	20	10	8	3	8,75

E40MF...	CODICE - CODE			E40MF...XP
	E40MF...V	E40MF...T		
◊	◊	◊	◊	
◊	◊	◊	◊	
●	◊	◊	◊	
◊	◊	◊	◊	
●	◊	◊	◊	
◊	◊	◊	◊	
●	◊	◊	◊	

Segue diametri
Diameters, to be continued
Diamètres à suivre

▶ Pag. 116

Confezione / Box / Colis: M3 – M10: 10 pezzi / pcs M12 – M16: 5 pezzi / pcs	€ Pag. listino - Price list - Liste des prix	56	56	56	56
	● Standard	○ Disponibilità da richiedere, prezzo a listino On enquiry, standard price-list / Stock à vérifier		★ Solo a richiesta Only on request / Sur demande	

MASCHI A MACCHINA

MACHINE TAPS - TARAUDS MACHINE

MF

DIN 371

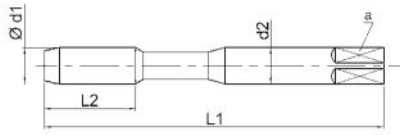

DIN 374

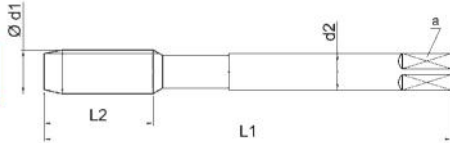

LINE



R15°

LINE



R15°

Profond. di filettatura - Thread depth - Profond. de filetage

Materiale - Material - Matériau

Tolleranza - Tolerance - Tolérance

Trattamento superficiale - Surface treatment - Revêtement

2,5xD

2,5xD

HSSE

HSSE

ISO2/6H

ISO2/6H

BR

TiN

Numero gruppi materiali

Material's groups number

Nombre de groupes du matériau

1.1	1.2	1.3	1.4	1.1	1.2	1.3	1.4
4.1	4.2			3.3	3.4		
5.1	5.2			4.1	4.2	4.3	
				5.1	5.2		

DIN 371	Ød1 MF	P mm	L ₁	L ₂	d ₂ h9	a h12	Z	
	8	1	90	18	8	6,2	3	7
	10	1	90	15	10	8	3	9
	10	1,25	100	20	10	8	3	8,75

CODICE - CODE	
E40MF...FOR	E40MF...FOR-T
○	○
○	○
○	○

DIN 374	Ød1 MF	P mm	L ₁	L ₂	d ₂ h9	a h12	Z	
	12	1,25	100	22	9	7	3	10,75
	12	1,5	100	22	9	7	3	10,5
	14	1,5	100	22	11	9	3	12,5
	16	1,5	100	22	12	9	3	14,5

CODICE - CODE	
E41MF...FOR	E41MF...FOR-T
○	○
○	○
○	○
○	○

Confezione / Box / Colis:
M3 – M10: 10 pezzi / pcs
M12 – M16: 5 pezzi / pcs

€ Pag. listino - Price list - Liste des prix

58

58

● Standard

○ Disponibilità da richiedere, prezzo a listino
On enquiry, standard price-list / Stock à vérifier

★ Solo a richiesta
Only on request / Sur demande

MF Filettatura metrica ISO passo fine DIN 13

ISO metric fine thread DIN13
 Metrisches ISO-Feingewinde DIN 13 – Maschinengewindebohrer
 Filetage métrique ISO à pas fin DIN 13 – Tarauds machine
 Rosca ISO métrica fina DIN 13 – Machos de roscar a máquina



Ti

TITANIO
Titanium - Titane

MASCHI A MACCHINA

MACHINE TAPS - TARAUDS MACHINE

DIN 371

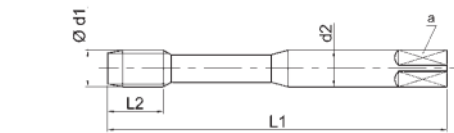

DIN 374

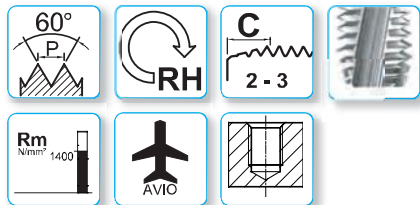
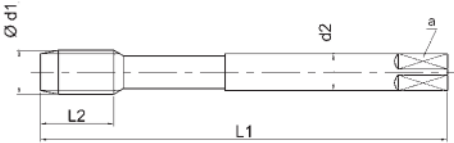

TOP



R15°

TOP



R15°

TOP



R15°

Profond. di filettatura - Thread depth - Profond. de filetage

Materiale - Material - Matériau

Tolleranza - Tolerance - Tolérance

Trattamento superficiale - Surface treatment - Revêtement

Numero gruppi materiali
Material's groups number
Nombre de groupes du matériau

1,5xD	1,5xD	1,5xD
PM3	PM3	PM3
6HX	6HX	4H
V	TiCN	V
6.1	1.6 2.4	6.1
	3.3 3.4	
	4.4 5.3 5.4 6.2 6.3	
	7.2 9.2	

DIN 371	Ød1 MF	P mm	L ₁	L ₂	d ₂ h9	a h12	Z	
	8	1	90	13	8	6,2	3	*7
	10	1	100	15	10	8	3	*9
	10	1,25	100	15	10	8	3	*8,75

CODICE - CODE		
K42MF...V	K42MF...CT	*K42MJF...V
<input type="checkbox"/>	<input type="checkbox"/>	<input type="checkbox"/>
<input type="checkbox"/>	<input type="checkbox"/>	<input type="checkbox"/>
<input type="checkbox"/>	<input type="checkbox"/>	<input type="checkbox"/>

DIN 374	Ød1 MF	P mm	L ₁	L ₂	d ₂ h9	a h12	Z	
	12	1,25	100	13	9	7	4	*10,75
	12	1,5	100	13	9	7	4	*10,5
	14	1,5	100	15	11	9	4	*12,5
	16	1,5	100	15	12	9	4	*14,5

CODICE - CODE		
K43MF...V	K43MF...CT	*K43MJF...V
<input type="checkbox"/>	<input type="checkbox"/>	<input type="checkbox"/>
<input type="checkbox"/>	<input type="checkbox"/>	<input type="checkbox"/>
<input type="checkbox"/>	<input type="checkbox"/>	<input type="checkbox"/>
<input type="checkbox"/>	<input type="checkbox"/>	<input type="checkbox"/>

* Per MJ vedi tabella di foratura pag. 252
 * Drills' diameters for MJ: table page 252
 * Pour MJ voir le tableau de perçage page 252

* Rivestimento TiCN a richiesta
 * TiCN coating on request
 * Revêtement TiCN sur demande

Confezione / Box / Colis: M3 – M10: 10 pezzi / pcs M12 – M16: 5 pezzi / pcs	€ Pag. listino - Price list - Liste des prix	59	59	59
● Standard	▷ Disponibilità da richiedere, prezzo a listino On enquiry, standard price-list / Stock à vérifier			* Solo a richiesta Only on request / Sur demande

Ni NICHEL
Nickel - Nickel

MASCHI A MACCHINA
MACHINE TAPS - TARAUDS MACHINE

UFS norm

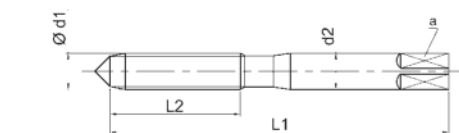

UFS norm

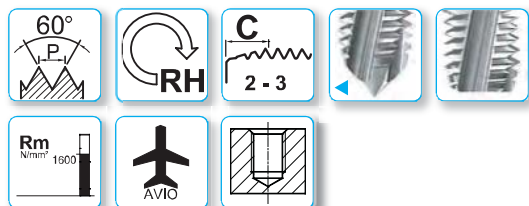
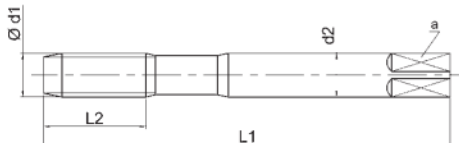

TOP



R10°

TOP



R10°

TOP



R10°

Profond. di filettatura - Thread depth - Profond. de filetage

Materiale - Material - Matériau

Tolleranza - Tolerance - Tolérance

Trattamento superficiale - Surface treatment - Revêtement

1,5xD	1,5xD	1,5xD
PM3	PM3	PM3
6HX	6HX	4HX
BR	TiCN	BR
7.3 9.3	1.6 5.4	7.3 9.3
	7.2 9.1	

Numero gruppi materiali
Material's groups number
Nombre de groupes du matériau

UFS norm	Ød1 MF	P mm	L ₁	L ₂	d ₂ h9	a h12	Z	
◀	8	1	90	25	8	6,2	3	*7
◀	10	1	100	30	10	8	3	*9
◀	10	1,25	100	30	10	8	3	*8,75
	12	1,25	110	30	12	9	4	*10,75
	12	1,5	110	30	12	9	4	*10,5
	14	1,5	110	30	12	9	4	*12,5
	16	1,5	110	30	16	12	4	*12,5

K42MF...NI	CODICE - CODE	
	K42MF...NI-CT	K42MF...NI-4HX
◊	◊	*
◊	◊	*
◊	◊	*
◊	◊	*
◊	◊	*
◊	◊	*
◊	◊	*

* Per MJ vedi tabella di foratura pag. 252
* Drills' diameters for MJ: table page 252
* Pour MJ voir le tableau de perçage page 252

Confezione / Box / Colis: M3 – M10: 10 pezzi / pcs M12 – M16: 5 pezzi / pcs	€ Pag. listino - Price list - Liste des prix	59	59	59
	● Standard	○ Disponibilità da richiedere, prezzo a listino On enquiry, standard price-list / Stock à vérifier		★ Solo a richiesta Only on request / Sur demande

MF Filettatura metrica ISO passo fine DIN 13

ISO metric fine thread DIN13
 Metrisches ISO-Feingewinde DIN 13 – Maschinengewindebohrer
 Filetage métrique ISO à pas fin DIN 13 – Tarauds machine
 Rosca ISO métrica fina DIN 13 – Machos de rosca a máquina



N USO GENERALE
 General purpose - Usage Général

MASCHI A MACCHINA

MACHINE TAPS - TARAUDS MACHINE

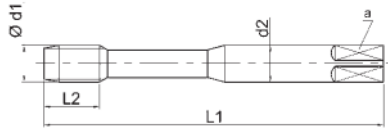
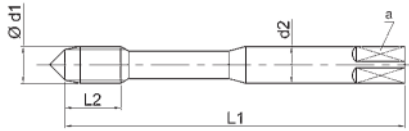

DIN 371

DIN 371

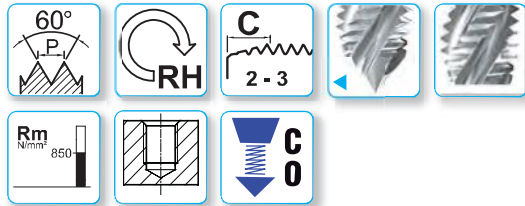

R40°

R40°

R40°

R40°

Profond. di filettatura - Thread depth - Profond. de filetage

Materiale - Material - Matériau

Tolleranza - Tolerance - Tolérance

Trattamento superficiale - Surface treatment - Revêtement

Numero gruppi materiali
 Material's groups number
 Nombre de groupes du matériau

2,5xD	2,5xD	2,5xD	2,5xD
HSSE	HSSE	HSSE	HSSE
ISO2/6H	ISO2/6H	ISO2/6H	ISO2/6H
BR	V	TiN	TxC
1.1 1.2 1.3 1.4	1.1 1.2 1.3 1.4	1.1 1.2 1.3 1.4	1.1 1.2 1.3 1.4
4.1 4.2	4.1 4.2	3.3 3.4	2.1 2.2 3.3 3.4
5.1 5.2	5.1 5.2	4.1 4.2 4.3	4.2 4.3
		5.1 5.2	5.2

DIN 371	Ød1 MF	P mm	L ₁	L ₂	d ₂ h9	a h12	Z	
◀	4	0,5	63	7	4,5	3,4	3	3,5
◀	5	0,5	70	8	6	4,9	3	4,5
◀	6	0,75	80	10	6	4,9	3	5,25
	8	0,75	90	13	8	6,2	3	7,25
	8	1	90	13	8	6,2	3	7
	10	1	90	15	10	8	3	9
	10	1,25	100	15	10	8	3	8,75

CODICE - CODE			
E60MF...	E60MF...V	E60MF...T	E60MF...TxC
○	○	○	○
○	○	○	○
●	○	○	●
○	○	○	○
●	○	○	●
●	○	○	●
●	○	○	●
●	○	○	●

Segue diametri
 Diameters, to be continued
 Diamètres à suivre

▶ Pag. 123...126

Confezione / Box / Colis: M3 – M10: 10 pezzi / pcs M12 – M16: 5 pezzi / pcs	€ Pag. listino - Price list - Liste des prix	59	59	59	60
	● Standard	▷ Disponibilità da richiedere, prezzo a listino On enquiry, standard price-list / Stock à vérifier		★ Solo a richiesta Only on request / Sur demande	

N **USO GENERALE**
General purpose - Usage Général

MASCHI A MACCHINA
MACHINE TAPS - TARAUDS MACHINE

DIN 371

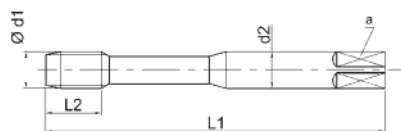

DIN 374

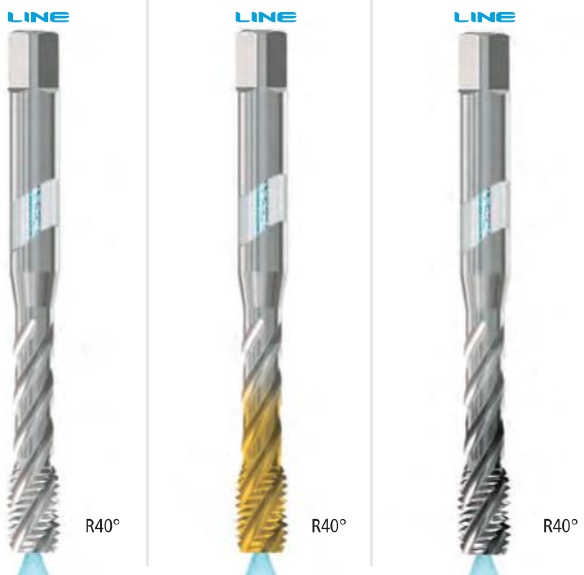
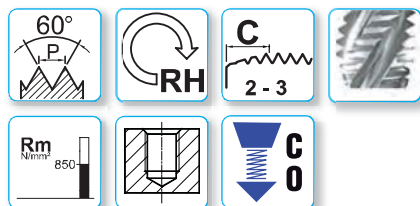

Profond. di filettatura - Thread depth - Profond. de filetage
Materiale - Material - Matériau
Tolleranza - Tolerance - Tolérance
Trattamento superficiale - Surface treatment - Revêtement

3xD	3xD	3xD
HSSE	HSSE	HSSE
ISO2/6H	ISO2/6H	ISO2/6H
BR	TiN	TXC
1.1 1.2 1.3 1.4	1.1 1.2 1.3 1.4	1.1 1.2 1.3 1.4
4.1 4.2	3.3 3.4	2.1 2.2 3.3 3.4
5.1 5.2	4.1 4.2 4.3	4.2 4.3
	5.1 5.2	5.2

Numero gruppi materiali
Material's groups number
Nombre de groupes du matériau

DIN 371	Ød1 MF	P mm	L ₁	L ₂	d ₂ h9	a h12	Z	
	8	1	90	13	8	6,2	3	7
	10	1	90	15	10	8	3	9
	10	1,25	100	15	10	8	3	8,75

CODICE - CODE		
E60MF...FOR	E60MF...FOR-T	E60MF...FOR-TXC
○	○	○
○	○	○
○	○	○

DIN 374	Ød1 MF	P mm	L ₁	L ₂	d ₂ h9	a h12	Z	
	12	1,25	100	13	9	7	3	10,75
	12	1,5	100	13	9	7	3	10,5
	14	1,5	100	15	11	9	4	12,5
	16	1,5	100	15	12	9	4	14,5

CODICE - CODE		
E61MF...FOR	E61MF...FOR-T	E61MF...FOR-TXC
○	○	○
○	○	○
○	○	○
○	○	○

Confezione / Box / Colis: M3 – M10: 10 pezzi / pcs M12 – M16: 5 pezzi / pcs	€ Pag. listino - Price list - Liste des prix	62	62	62
	● Standard	○ Disponibilità da richiedere, prezzo a listino On enquiry, standard price-list / Stock à vérifier	○	★ Solo a richiesta Only on request / Sur demande

MASCHI A MACCHINA, FILETTATURA SINISTRA

LEFT THREAD MACHINE TAPS - TARAUDS MACHINE GAUCHE

DIN 371

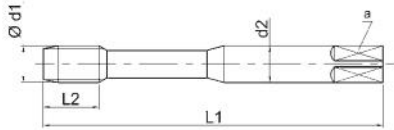

DIN 374

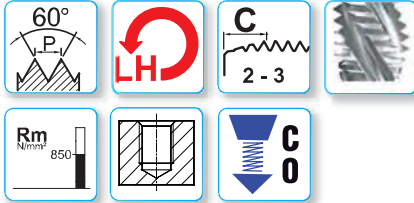
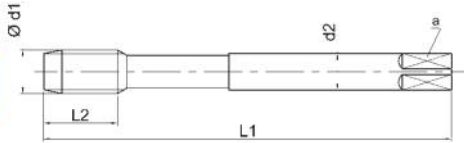

LINE



L 35°

LINE



L 35°

LINE



L 35°

Profond. di filettatura - Thread depth - Profond. de filetage

2,5xD

2,5xD

2,5xD

Materiale - Material - Matériau

HSSE

HSSE

HSSE

Tolleranza - Tolerance - Tolérance

ISO2/6H

ISO2/6H

ISO2/6H

Trattamento superficiale - Surface treatment - Revêtement

BR

V

XP

Numero gruppi materiali

Material's groups number

Nombre de groupes du matériau

1.1 1.2 1.3 1.4

1.1 1.2 1.3 1.4

1.1 1.2 1.3 1.4

4.1 4.2

4.1 4.2

2.1 2.2 3.3 3.4

5.1 5.2

5.1 5.2

4.2 4.3

5.2

DIN 371	Ød1 MF	P mm	L ₁	L ₂	d ₂ h9	a h12	Z	
	8	1	90	13	8	6,2	3	7
	10	1	90	15	10	8	3	9
	10	1,25	100	15	10	8	3	8,75

CODICE - CODE		
E60MF...LH	E60MF...LH-V	E60MF...LH-XP
<input type="checkbox"/>	<input type="checkbox"/>	<input type="checkbox"/>
<input type="checkbox"/>	<input type="checkbox"/>	<input type="checkbox"/>
<input type="checkbox"/>	<input type="checkbox"/>	<input type="checkbox"/>

DIN 374	Ød1 MF	P mm	L ₁	L ₂	d ₂ h9	a h12	Z	
	8	1	90	13	6	4,9	3	7
	10	1	90	15	7	5,5	3	9
	10	1,25	100	15	7	5,5	3	8,75
	12	1,25	100	13	9	7	3	10,75
	12	1,5	100	13	9	7	3	10,5
	14	1,5	100	15	11	9	4	12,5
	16	1,5	100	15	12	9	4	14,5

CODICE - CODE		
E61MF...LH	E61MF...LH-V	E61MF...LH-XP
<input type="checkbox"/>	<input type="checkbox"/>	<input type="checkbox"/>
<input type="checkbox"/>	<input type="checkbox"/>	<input type="checkbox"/>
<input type="checkbox"/>	<input type="checkbox"/>	<input type="checkbox"/>
<input type="checkbox"/>	<input type="checkbox"/>	<input type="checkbox"/>
<input type="checkbox"/>	<input type="checkbox"/>	<input type="checkbox"/>
<input type="checkbox"/>	<input type="checkbox"/>	<input type="checkbox"/>

Confezione / Box / Colis:
M3 – M10: 10 pezzi / pcs
M12 – M16: 5 pezzi / pcs

€ Pag. listino - Price list - Liste des prix

63

63

63

● Standard

▷ Disponibilità da richiedere, prezzo a listino
On enquiry, standard price-list / Stock à vérifier

★ Solo a richiesta
Only on request / Sur demande

N USO GENERALE
General purpose - Usage Général

MASCHI A MACCHINA
MACHINE TAPS - TARAUDS MACHINE

DIN 371

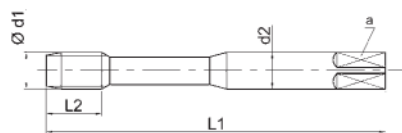

DIN 374

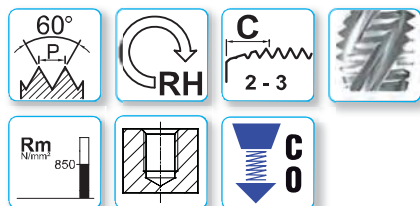
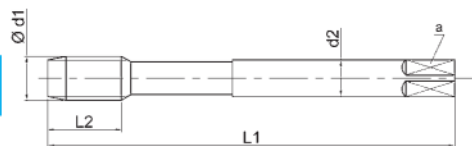

LINE



R40°

LINE



R40°

LINE



R40°

LINE



R40°



Profond. di filettatura - Thread depth - Profond. de filetage

Materiale - Material - Matériau

Tolleranza - Tolerance - Tolérance

Trattamento superficiale - Surface treatment - Revêtement

Numero gruppi materiali
Material's groups number
Nombre de groupes du matériau

2,5xD	2,5xD	2,5xD	2,5xD
HSSE	HSSE	HSSE	HSSE
ISO1/4H	ISO3/6G	7G(6H+0,05)	6H+0,1
BR	BR	BR	BR
1.1 1.2 1.3 1.4	1.1 1.2 1.3 1.4	1.1 1.2 1.3 1.4	1.1 1.2 1.3 1.4
4.1 4.2	4.1 4.2	4.1 4.2	4.1 4.2
5.1 5.2	5.1 5.2	5.1 5.2	5.1 5.2

DIN 371	Ød1 MF	P mm	L ₁	L ₂	d ₂ h9	a h12	Z	
	8	1	90	13	8	6,2	3	7
	10	1	90	15	10	8	3	9
	10	1,25	100	15	10	8	3	8,75

CODICE - CODE			
E60MF...-4H	E60MF...-6G	E60MF...-7G	E60MF...+0,1
*	*	*	*
*	*	*	*
*	*	*	*

DIN 374	Ød1 MF	P mm	L ₁	L ₂	d ₂ h9	a h12	Z	
	8	1	90	13	6	4,9	3	7
	10	1	90	15	7	5,5	3	9
	10	1,25	100	15	7	5,5	3	8,75
	12	1,25	100	13	9	7	3	10,75
	12	1,5	100	13	9	7	3	10,5
	14	1,5	100	15	11	9	4	12,5
	16	1,5	100	15	12	9	4	14,5

CODICE - CODE			
E61MF...-4H	E61MF...-6G	E61MF...-7G	E61MF...+0,1
o	o	o	o
o	o	o	o
o	o	o	o
o	o	o	o
o	o	o	o
o	o	o	o
o	o	o	o

Confezione / Box / Colis: M3 – M10: 10 pezzi / pcs M12 – M16: 5 pezzi / pcs	€ Pag. listino - Price list - Liste des prix	63	63	63	63
	● Standard	○ Disponibilità da richiedere, prezzo a listino On enquiry, standard price-list / Stock à vérifier		★ Solo a richiesta Only on request / Sur demande	

N **USO GENERALE R ≤ 1000N/mm²**
 General purpose R ≤ 1000N/mm² - Usage Général R ≤ 1000N/mm²

MASCHI A MACCHINA
 MACHINE TAPS - TARAUDS MACHINE

DIN 371

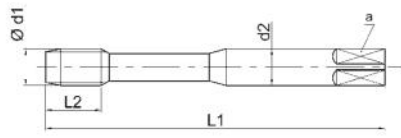

DIN 374

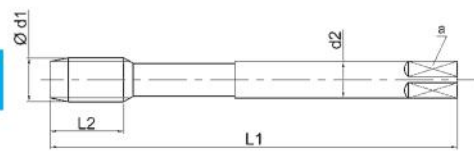

60° P
 RH
 C 2-3
 Rm N/mm² 1000 850
 8%Co
 SR

Profond. di filettatura - Thread depth - Profond. de filetage	2,5xD	2,5xD	2,5xD	2,5xD
Materiale - Material - Matériau	HSSP	HSSP	HSSP	HSSP
Tolleranza - Tolerance - Tolérance	ISO2/6H	ISO2/6H	ISO2/6H	ISO2/6H
Trattamento superficiale - Surface treatment - Revêtement	BR	V	TiN	XP
Numero gruppi materiali Material's groups number Nombre de groupes du matériau	1.1 1.2 1.3 1.4	1.1 1.2 1.3 1.4	1.1 1.2 1.3 1.4 1.5	1.1 1.2 1.3 1.4 1.5
	4.1 4.2	4.1 4.2	3.3 3.4 4.1 4.2 4.3	2.1 2.2
	5.1 5.2	5.1 5.2	5.1 5.2	3.3 3.4 4.2 4.3
				5.2

DIN 371	Ød1 MF	P mm	L ₁	L ₂	d ₂ h9	a h12	Z	
	8	1	90	13	8	6,2	3	7
	10	1	90	15	10	8	3	9
	10	1,25	100	15	10	8	3	8,75

P60MF...	CODICE - CODE		
	P60MF...V	P60MF...T	P60MF...XP
○	○	○	○
○	○	○	○
○	○	○	○

DIN 374	Ød1 MF	P mm	L ₁	L ₂	d ₂ h9	a h12	Z	
	8	1	90	13	6	4,9	3	7
	10	1	90	15	7	5,5	3	9
	10	1,25	100	15	7	5,5	3	8,75
	12	1	100	13	9	7	4	11
	12	1,25	100	13	9	7	4	10,75
	12	1,5	100	13	9	7	4	10,5
	14	1,5	100	15	11	9	4	12,5
	16	1,5	100	15	12	9	4	14,5
	18	1,5	110	17	14	11	4	16,5
	20	1,5	125	17	16	12	4	18,5

P61MF...	CODICE - CODE		
	P61MF...V	P61MF...T	P61MF...XP
○	○	○	○
○	○	○	○
○	○	○	○
○	○	○	○
○	○	○	○
○	○	○	○
*	*	*	*
*	*	*	*
*	*	*	*

★ **Solo a richiesta**
 Only on request / Sur demande

RACCOMANDATO per filettatura rigida
 We recommend Syncro rigid threading
 Recommandé pour le taraudage rigide



Confezione / Box / Colis: M3 – M10: 10 pezzi / pcs M12 – M16: 5 pezzi / pcs	€ Pag. listino - Price list - Liste des prix	64	64	64	64
	● Standard	○ Disponibilità da richiedere, prezzo a listino On enquiry, standard price-list / Stock à vérifier			

MF Filettatura metrica ISO passo fine DIN 13

ISO metric fine thread DIN13
 Metrisches ISO-Feingewinde DIN 13 – Maschinengewindebohrer
 Filetage métrique ISO à pas fin DIN 13 – Tarauds machine
 Rosca ISO métrica fina DIN 13 – Machos de roscar a máquina



N USO GENERALE
 General purpose - Usage Général

MASCHI A MACCHINA

MACHINE TAPS - TARAUDS MACHINE

MF

DIN 371

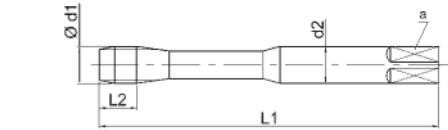

DIN 374

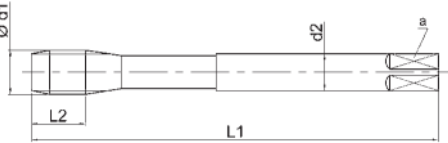

60° P
 RH
 C 2-3
 Rm 850
 Back Tapered BT
 SR



Profond. di filettatura - Thread depth - Profond. de filetage	2,5÷3xD	2,5÷3xD	2,5÷3xD	2,5÷3xD
Materiale - Material - Matériau	HSSE	HSSE	HSSE	HSSE
Tolleranza - Tolerance - Tolérance	ISO2/6H	ISO2/6H	ISO2/6H	ISO2/6H
Trattamento superficiale - Surface treatment - Revêtement	BR	V	TiN	XP
Numero gruppi materiali Material's groups number Nombre de groupes du matériau	1.1 1.2 1.3 1.4	1.1 1.2 1.3 1.4	1.1 1.2 1.3 1.4	1.1 1.2 1.3 1.4
	5.1 5.2	2.1 2.2	5.1 5.2	2.1 2.2
		5.1 5.2		5.2

DIN 371	Ød1 MF	P mm	L1	L2	d2 h9	a h12	Z	
	8	1	90	13	8	6,2	3	7
	10	1	90	15	10	8	3	9
	10	1,25	100	15	10	8	3	8,75

CODICE - CODE			
E80MF...	E80MF...V	E80MF...T	E80MF...XP
<input type="radio"/>	<input type="radio"/>	<input type="radio"/>	<input type="radio"/>
<input type="radio"/>	<input type="radio"/>	<input type="radio"/>	<input type="radio"/>
<input type="radio"/>	<input type="radio"/>	<input type="radio"/>	<input type="radio"/>

DIN 374	Ød1 MF	P mm	L1	L2	d2 h9	a h12	Z	
	8	1	90	13	6	4,9	3	7
	10	1	90	15	7	5,5	3	9
	10	1,25	100	15	7	5,5	3	8,75
	12	1	100	13	9	7	3	11
	12	1,25	100	13	9	7	3	10,75
	12	1,5	100	13	9	7	3	10,5
	14	1,5	100	15	11	9	4	12,5
	16	1,5	100	15	12	9	4	14,5
	18	1,5	110	17	14	11	4	16,5
	20	1,5	125	17	16	12	4	18,5

CODICE - CODE			
E81MF...	E81MF...V	E81MF...T	E81MF...XP
<input checked="" type="radio"/>	<input type="radio"/>	<input type="radio"/>	<input type="radio"/>
<input checked="" type="radio"/>	<input type="radio"/>	<input type="radio"/>	<input type="radio"/>
<input checked="" type="radio"/>	<input type="radio"/>	<input type="radio"/>	<input type="radio"/>
<input checked="" type="radio"/>	<input type="radio"/>	<input type="radio"/>	<input type="radio"/>
<input checked="" type="radio"/>	<input type="radio"/>	<input type="radio"/>	<input type="radio"/>
<input checked="" type="radio"/>	<input type="radio"/>	<input type="radio"/>	<input type="radio"/>
<input checked="" type="radio"/>	<input type="radio"/>	<input type="radio"/>	<input type="radio"/>
<input checked="" type="radio"/>	<input type="radio"/>	<input type="radio"/>	<input type="radio"/>
<input checked="" type="radio"/>	<input type="radio"/>	<input type="radio"/>	<input type="radio"/>
<input checked="" type="radio"/>	<input type="radio"/>	<input type="radio"/>	<input type="radio"/>

RACCOMANDATO per filettatura rigida
 We recommend Syncro rigid threading
 Recommandé pour le taraudage rigide

***** Ad esaurimento scorte / Stock clearance - Stock épuisé
 Vedi nuova serie - See new series - Voir nouvelle série E93 pag. XXXIV

Confezione / Box / Colis: M3 – M10: 10 pezzi / pcs M12 – M16: 5 pezzi / pcs	€ Pag. listino - Price list - Liste des prix ● Standard	64	64	64	64
		↳ Disponibilità da richiedere, prezzo a listino On enquiry, standard price-list / Stock à vérifier		* Solo a richiesta Only on request / Sur demande	

MF Filettatura metrica ISO passo fine DIN 13

ISO metric fine thread DIN13

Metrisches ISO-Feingewinde DIN 13 – Maschinengewindebohrer
 Filetage métrique ISO à pas fin DIN 13 – Tarauds machine
 Rosca ISO métrica fina DIN 13 – Machos de roscar a máquina



P - SERIES

MASCHI A RULLARE
 Roll form taps - Tarauds à refoiler

MASCHI A MACCHINA

MACHINE TAPS - TARAUDS MACHINE

DIN 371

DIN 371

DIN 374

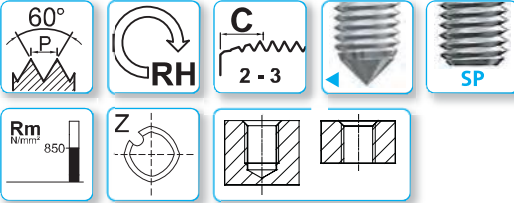
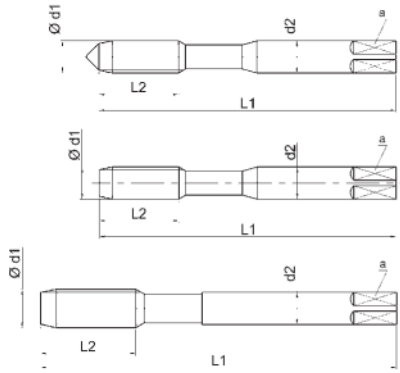

Profond. di filettatura - Thread depth - Profond. de filetage
 Materiale - Material - Matériau
 Tolleranza - Tolerance - Tolérance
 Trattamento superficiale - Surface treatment - Revêtement

3xD HSSP 6HX
 3xD HSSP 6HX
 3xD HSSP 6HX
 BR V TiN

Numero gruppi materiali
 Material's groups number
 Nombre de groupes du matériau

1.1 1.2 1.3	1.1 1.2	1.1 1.2 1.3 1.4
4.1 4.2	4.1 4.2	2.1 2.2 2.3
	5.1 5.2	4.1 4.2 4.3
		5.1 5.2

DIN 371	Ød1 MF	P mm	L ₁	L ₂	d ₂ h9	a h12	Z	
◀	4	0,5	63	13	4,5	3,4	4	3,80
◀	5	0,5	70	13	6	4,9	5	4,80
◀	6	0,75	80	16	6	4,9	5	5,65
◀	8	0,75	90	18	8	6,2	5	7,65
◀	8	1	90	18	8	6,2	5	7,55
◀	10	1	90	15	10	8	5	9,55
◀	10	1,25	100	20	10	8	5	9,40
	8	1	90	18	8	6,2	5	7,55
	10	1	90	15	10	8	5	9,55
	10	1,25	100	20	10	8	5	9,40

P2CCMF...	CODICE - CODE	
	P2CCMF...V	P2CCMF...T
○	○	○
○	○	○
○	○	○
○	○	○
●	○	○
●	○	○
●	○	○
P2CCMF...SP	P2CCMF...SP-V	P2CCMF...SP-T
○	○	○
○	○	○
○	○	○

DIN 374	Ød1 MF	P mm	L ₁	L ₂	d ₂ h9	a h12	Z	
	12	1	100	22	9	7	6	11,55
	12	1,25	100	22	9	7	6	11,40
	12	1,5	100	22	9	7	6	11,30
	14	1,25	100	22	11	9	6	13,45
	14	1,5	100	22	11	9	6	13,30
	16	1,5	100	22	12	9	6	15,30
	18	1,5	110	25	14	11	6	17,30
	20	1,5	125	25	16	12	8	19,30

P2CCMF...	CODICE - CODE	
	P2CCMF...V	P2CCMF...T
○	○	○
●	○	○
●	○	○
○	○	○
○	○	○
●	○	○
●	○	○
○	○	○
○	○	○

★ Ad esaurimento scorte
 Stock clearance - Stock épuisé

Confezione / Box / Colis: M3 – M10: 10 pezzi / pcs M12 – M16: 5 pezzi / pcs	€ Pag. listino - Price list - Liste des prix ● Standard	68 ○ Disponibilità da richiedere, prezzo a listino On enquiry, standard price-list / Stock à vérifier	68 ★ Solo a richiesta Only on request / Sur demande
---	--	---	---

MF Filettatura metrica ISO passo fine DIN 13

ISO metric fine thread DIN13
 Metrisches ISO-Feingewinde DIN 13 – Maschinengewindebohrer
 Filetage métrique ISO à pas fin DIN 13 – Tarauds machine
 Rosca ISO métrica fina DIN 13 – Machos de roscar a máquina



P - SERIES

MASCHI A RULLARE
 Roll form taps - Tarauds à refoiler

MASCHI A MACCHINA

MACHINE TAPS - TARAUDS MACHINE

MF

DIN 371

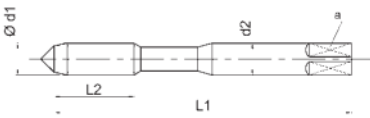

DIN 374

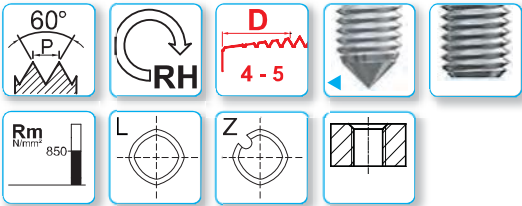
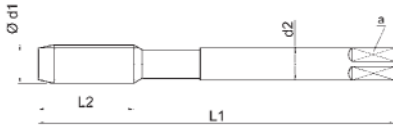

Profond. di filettatura - Thread depth - Profond. de filetage

Materiale - Material - Matériau

Tolleranza - Tolerance - Tolérance

Trattamento superficiale - Surface treatment - Revêtement

Numero gruppi materiali
 Material's groups number
 Nombre de groupes du matériau

3xD	3xD	3xD	3xD
HSSP	HSSP	HSSP	HSSP
6HX	6HX	6HX	6HX
BR	TiN	BR	TiN
1.1 1.2 1.3	1.1 1.2 1.3 1.4	1.1 1.2 1.3	1.1 1.2 1.3 1.4
4.1 4.2	2.1 2.2 2.3	4.1 4.2	2.1 2.2 2.3
	4.1 4.2 4.3		4.1 4.2 4.3
	5.1 5.2		5.1 5.2

DIN 371	Ød1 MF	P mm	L ₁	L ₂	d ₂ h9	a h12	Z	
◀	8	1	90	18	8	6,2	5	7,55
◀	10	1	90	15	10	8	5	9,55
◀	10	1,25	100	20	10	8	5	9,40

CODICE - CODE			
P2SCMF...FP	P2SCMF...FP-T	P2CCMF...FP	P2CCMF...FP-T
*	*	*	*
*	*	*	*
*	*	*	*

DIN 374	Ød1 MF	P mm	L ₁	L ₂	d ₂ h9	a h12	Z	
	12	1	100	22	9	7	6	11,55
	12	1,5	100	22	9	7	6	11,30
	14	1,5	100	22	11	9	6	13,30
	16	1,5	100	22	12	9	6	15,30
	18	1,5	110	25	14	11	6	17,30
	20	1,5	125	25	16	12	8	19,30

CODICE - CODE			
P2SCMF...FP	P2SCMF...FP-T	P2CCMF...FP	P2CCMF...FP-T
*	*	*	*
*	*	*	*
*	*	*	*
*	*	*	*
*	*	*	*
*	*	*	*

Ad esaurimento scorte
 Stock clearance - Stock épuisé

Confezione / Box / Colis:	€ Pag. listino - Price list - Liste des prix	69	69	69	69
M3 – M10: 10 pezzi / pcs M12 – M16: 5 pezzi / pcs	● Standard	○ Disponibilità da richiedere, prezzo a listino On enquiry, standard price-list / Stock à vérifier		★ Solo a richiesta Only on request / Sur demande	

P - SERIES

MASCHI A RULLARE

Roll form taps - Tarauds à refouler

MASCHI A MACCHINA, FILETTATURA SINISTRA

LEFT THREAD MACHINE TAPS - TARAUDS MACHINE GAUCHE

DIN 371

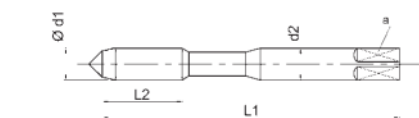

DIN 374

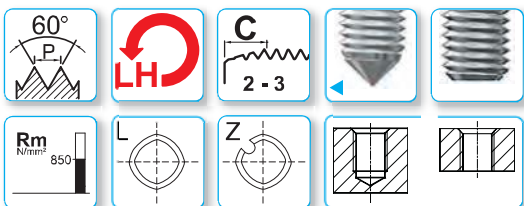
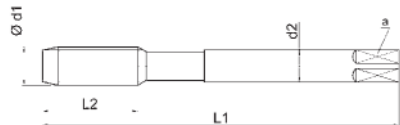

Profond. di filettatura - Thread depth - Profond. de filetage
Materiale - Material - Matériau
Tolleranza - Tolerance - Tolérance
Trattamento superficiale - Surface treatment - Revêtement

3xD	3xD	3xD	3xD
HSSP	HSSP	HSSP	HSSP
6HX	6HX	6HX	6HX
BR	TiN	BR	TiN
1.1 1.2 1.3	1.1 1.2 1.3 1.4	1.1 1.2 1.3	1.1 1.2 1.3 1.4
4.1 4.2	2.1 2.2 2.3	4.1 4.2	2.1 2.2 2.3
	4.1 4.2 4.3		4.1 4.2 4.3
	5.1 5.2		5.1 5.2

Numero gruppi materiali
Material's groups number
Nombre de groupes du matériau

DIN 371	Ød1 MF	P mm	L ₁	L ₂	d ₂ h9	a h12	Z	
◀	8	1	90	18	8	6,2	5	7,55
◀	10	1	90	15	10	8	5	9,55
◀	10	1,25	100	20	10	8	5	9,40

CODICE - CODE			
P2SCMF...LH	P2SCMF...LH-T	P2CCMF...LH	P2CCMF...LH-T
⌋	⌋	⌋	⌋
⌋	⌋	⌋	⌋
⌋	⌋	⌋	⌋

DIN 374	Ød1 MF	P mm	L ₁	L ₂	d ₂ h9	a h12	Z	
	12	1	100	22	9	7	6	11,55
	12	1,5	100	22	9	7	6	11,30
	14	1,5	100	22	11	9	6	13,30
	16	1,5	100	22	12	9	6	15,30
	18	1,5	110	25	14	11	6	17,30
	20	1,5	125	25	16	12	8	19,30

CODICE - CODE			
P2SCMF...LH	P2SCMF...LH-T	P2CCMF...LH	P2CCMF...LH-T
⌋	⌋	⌋	⌋
⌋	⌋	⌋	⌋
⌋	⌋	⌋	⌋
⌋	⌋	⌋	⌋
⌋	⌋	⌋	⌋
⌋	⌋	⌋	⌋

Confezione / Box / Colis: M3 – M10: 10 pezzi / pcs M12 – M16: 5 pezzi / pcs	€ Pag. listino - Price list - Liste des prix	69	69	69	69
	● Standard	○ Disponibilità da richiedere, prezzo a listino On enquiry, standard price-list / Stock à vérifier		★ Solo a richiesta Only on request / Sur demande	

MASCHI A MACCHINA

MACHINE TAPS - TARAUDS MACHINE

DIN 371

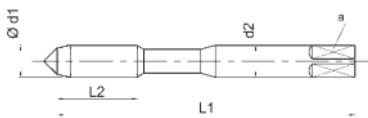

DIN 374

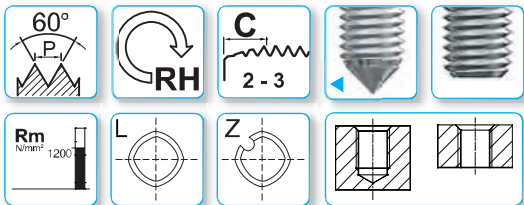
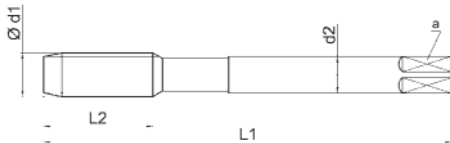

Profond. di filettatura - Thread depth - Profond. de filetage

Materiale - Material - Matériau

Tolleranza - Tolerance - Tolérance

Trattamento superficiale - Surface treatment - Revêtement

Numero gruppi materiali
 Material's groups number
 Nombre de groupes du matériau

3xD	3xD	3xD	3xD
PM3	PM3	PM3	PM3
6HX	6GX	6HX	6GX
TiN-G	TiN-G	TiN-G	TiN-G
1.1 1.2 1.3 1.4 1.5	1.1 1.2 1.3 1.4 1.5	1.1 1.2 1.3 1.4 1.5	1.1 1.2 1.3 1.4 1.5
2.1 2.2 2.3 2.4	2.1 2.2 2.3 2.4	2.1 2.2 2.3 2.4	2.1 2.2 2.3 2.4
4.1 4.2 4.3	4.1 4.2 4.3	4.1 4.2 4.3	4.1 4.2 4.3
5.1 5.2 7.1 7.2	5.1 5.2 7.1 7.2	5.1 5.2 7.1 7.2	5.1 5.2 7.1 7.2

DIN 371	Ød1 MF	P mm	L ₁	L ₂	d ₂ h9	a h12	Z	
◀	4	0,5	63	13	4,5	3,4	4	3,75
◀	5	0,5	70	13	6	4,9	5	4,75
◀	6	0,75	80	16	6	4,9	5	5,65
◀	8	1	90	18	8	6,2	5	7,55
◀	10	1	90	15	10	8	5	9,55
◀	10	1,25	100	20	10	8	5	9,45

CODICE - CODE			
X2SCMF...TG	X3SCMF...TG	X2CCMF...TG	X3CCMF...TG
○	○	○	○
○	○	○	○
○	○	○	○
○	○	○	○
○	○	○	○
○	○	○	○

DIN 374	Ød1 MF	P mm	L ₁	L ₂	d ₂ h9	a h12	Z	
	12	1	100	22	9	7	6	11,55
	12	1,25	100	22	9	7	6	11,45
	12	1,5	100	22	9	7	6	11,30
	14	1,25	100	22	11	9	6	13,45
	14	1,5	100	22	11	9	6	13,30
	16	1,5	100	22	12	9	6	15,30

CODICE - CODE			
X2SCMF...TG	X3SCMF...TG	X2CCMF...TG	X3CCMF...TG
○	○	○	○
○	○	○	○
○	○	○	○
○	○	○	○
○	○	○	○
○	○	○	○

★ Ad esaurimento scorte
 Stock clearance - Stock épuisé

Vedi nuova serie - See new series - Voir nouvelle série
 K-ROLL pag. XXXVIII

Confezione / Box / Colis: M3 – M10: 10 pezzi / pcs M12 – M16: 5 pezzi / pcs	€ Pag. listino - Price list - Liste des prix	70	70	70	70
● Standard	○ Disponibilità da richiedere, prezzo a listino On enquiry, standard price-list / Stock à vérifier	★ Solo a richiesta Only on request / Sur demande			

X - SERIES

MASCHI A RULLARE

Roll form taps - Tarauds à refouler

MASCHI A MACCHINA

MACHINE TAPS - TARAUDS MACHINE

DIN 371

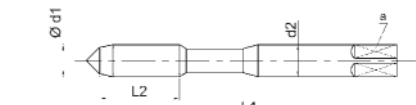

DIN 371

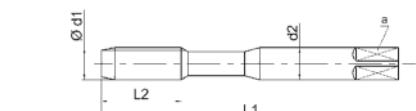

DIN 374

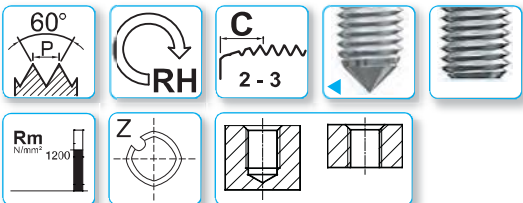
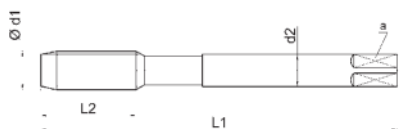

top



top



top



3xD

3xD

3xD

PM3

PM3

PM3

6HX

6HX

6HX

TXC

TiN-G

TiN-G

1.1 1.2	1.1 1.2 1.3 1.4 1.5	1.1 1.2 1.3 1.4 1.5
4.1 4.2 4.3	2.1 2.2 2.3 2.4	2.1 2.2 2.3 2.4
5.1 5.2	4.1 4.2 4.3	4.1 4.2 4.3
	5.1 5.2 7.1 7.2	5.1 5.2 7.1 7.2

Profond. di filettatura - Thread depth - Profond. de filetage

Materiale - Material - Matériau

Tolleranza - Tolerance - Tolérance

Trattamento superficiale - Surface treatment - Revêtement

Numero gruppi materiali

Material's groups number

Nombre de groupes du matériau

DIN 371	Ød1 MF	P mm	L1	L2	d2 h9	a h12	Z	
◀	8	1	90	18	8	6,2	5	7,55
◀	10	1	90	15	10	8	5	9,55
◀	10	1,25	100	20	10	8	5	9,45
	8	1	90	18	8	6,2	5	7,55
	10	1	90	15	10	8	5	9,55
	10	1,25	100	20	10	8	5	9,45
◀	8	1	90	18	8	6,2	2	7,55
◀	10	1	90	15	10	8	2	9,55
◀	10	1,25	100	20	10	8	2	9,45

CODICE - CODE		
X2CCMF...TXC		
○		
○		
○		
	X2CCMF...FOR-TG	
-	○	
-	○	
-	○	
		X2CCMF...FOR-TG
-	-	○ 4L/Z2
-	-	○ 4L/Z2
-	-	○ 4L/Z2

DIN 374	Ød1 MF	P mm	L1	L2	d2 h9	a h12	Z	
	12	1	100	22	9	7	6	11,55
	12	1,25	100	22	9	7	6	11,45
	12	1,5	100	22	9	7	6	11,30
	14	1,5	100	22	11	9	6	13,30
	16	1,5	100	22	12	9	6	15,30
	12	1	100	22	9	7	3	11,55
	12	1,25	100	22	9	7	3	11,45
	12	1,5	100	22	9	7	3	11,30
	14	1,5	100	22	11	9	3	13,30
	16	1,5	100	22	12	9	3	15,30

CODICE - CODE		
X2CCMF...TXC	X2CCMF...FOR-TG	
○	○	
○	○	
○	○	
○	○	
○	○	
		X2CCMF...FOR-TG
-	-	○ 6L/Z3
-	-	○ 6L/Z3
-	-	○ 6L/Z3
-	-	○ 6L/Z3
-	-	○ 6L/Z3

N° lobi
Lobes' Number
N° de Lobes

N° canalini
Oil grooves' Number
N° de rainures
de lubrifications



★ Ad esaurimento scorte
Stock clearance - Stock épuisé

★ Vedi nuova serie - See new series
Voir nouvelle série: K-ROLL pag. XXXIX

Confezione / Box / Colis:
M3 - M10: 10 pezzi / pcs
M12 - M16: 5 pezzi / pcs

€ Pag. listino - Price list - Liste des prix

● Standard

70
○ Disponibilità da richiedere, prezzo a listino
On enquiry, standard price-list / Stock à vérifier

70
★ Solo a richiesta
Only on request / Sur demande

MASCHI A MACCHINA

MACHINE TAPS - TARAUDS MACHINE

MF

DIN 371

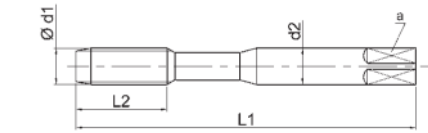

DIN 374

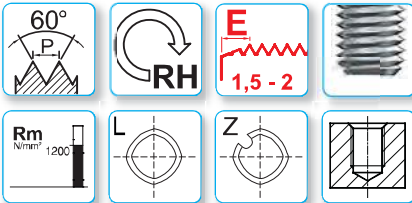
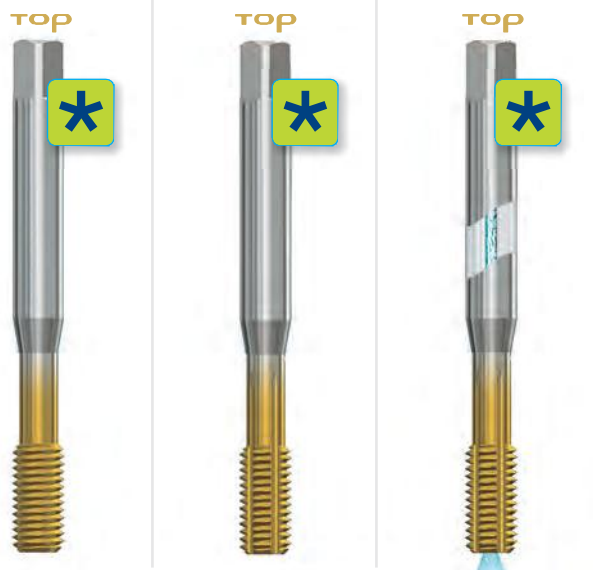
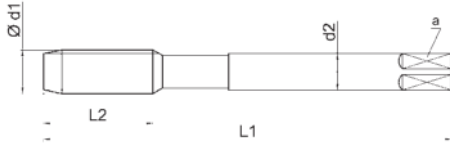

Profond. di filettatura - Thread depth - Profond. de filetage
 Materiale - Material - Matériau
 Tolleranza - Tolerance - Tolérance
 Trattamento superficiale - Surface treatment - Revêtement

3xD
 PM3
 6HX
 TiN-G

Numero gruppi materiali
 Material's groups number
 Nombre de groupes du matériau

1.1	1.2	1.3	1.4	1.5	1.1	1.2	1.3	1.4	1.5	1.1	1.2	1.3	1.4	1.5
2.1	2.2	2.3	2.4	2.1	2.2	2.3	2.4	2.1	2.2	2.3	2.4			
4.1	4.2	4.3	4.1	4.2	4.3	4.1	4.2	4.3						
5.1	5.2	7.1	7.2	5.1	5.2	7.1	7.2	5.1	5.2	7.1	7.2			

DIN 371	Ød1 MF	P mm	L1	L2	d2 h9	a h12	Z	
8	1	90	18	8	6,2	5	7,55	
10	1	90	15	10	8	5	9,55	
10	1,25	100	20	10	8	5	9,45	

CODICE - CODE		
X2SCMF...TG	X2CCMF...TG	X2CCMF...FOR-TG
○	○	○
○	○	○
○	○	○

DIN 374	Ød1 MF	P mm	L1	L2	d2 h9	a h12	Z	
12	1	100	22	9	7	6	11,55	
12	1,25	100	22	9	7	6	11,45	
12	1,5	100	22	9	7	6	11,30	
14	1,5	100	22	11	9	6	13,30	
16	1,5	100	22	12	9	6	15,30	

CODICE - CODE		
X2SCMF...TG	X2CCMF...TG	X2CCMF...FOR-TG
○	○	○
○	○	○
○	○	○
○	○	○
○	○	○

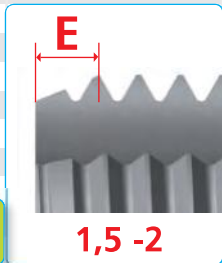

***** Ad esaurimento scorte
 Stock clearance - Stock épuisé

Vedi nuova serie - See new series - Voir nouvelle série
 K-ROLL pag. XL

Confezione / Box / Colis: M3 – M10: 10 pezzi / pcs M12 – M16: 5 pezzi / pcs	€ Pag. listino - Price list - Liste des prix ● Standard	71 ○ Disponibilità da richiedere, prezzo a listino On enquiry, standard price-list / Stock à vérifier	71 ★ Solo a richiesta Only on request / Sur demande
---	--	---	---

UNI 5870 - ISO 1502

LINE



Calibri a tampone filettati passa / non passa

Thread plug gauges go/no-go
 Calibres de filetage entre/n'entre pas



Tolleranza - Tolerance - Tolérance

6H

Trattamento superficiale - Surface treatment - Revêtement

BR

Ød1 MF	P mm	CODICE - CODE P-NPMF...
4	0,5	▷
5	0,5	▷
6	0,75	▷
7	0,75	▷
8	0,75	▷
8	1	▷
9	1	▷
10	0,75	▷
10	1	▷
10	1,25	▷
12	1	▷
12	1,25	▷
12	1,5	▷
14	1	▷
14	1,25	▷
14	1,5	▷
16	1	▷
16	1,5	▷
18	1	▷
18	1,5	▷
18	2	▷
20	1	▷
20	1,5	▷
20	2	▷
22	1	▷
22	1,5	▷
24	1	▷
24	1,5	▷
24	2	▷
25	1	▷
25	1,5	▷
25	2	▷
26	1,5	▷
26	2	▷

Segue diametri
 Diameters, to be continued / Diamètres à suivre ▶ Pag. 148

Confezione: Singola
 Box: Single
 Colis: Unique

€ Pag. listino - Price list - Liste des prix

108

● Standard

○ Disponibilità da richiedere, prezzo a listino
 On enquiry, standard price-list / Stock à vérifier

★ Solo a richiesta
 Only on request / Sur demande

CALIBRI FILETTATI

THREAD GAUGES - CALIBRES DE FILETAGE

UNI 5870 - ISO 1502

Calibri a tampone filettati passa / non passa

Thread plug gauges go/no-go

Calibres de filetage entre/n'entre pas



Tolleranza - Tolerance - Tolérance

6H

Trattamento superficiale - Surface treatment - Revêtement

BR

Ød1 MF	P mm	CODICE - CODE P-NPMF...
27	1	○
27	1,5	○
28	1,5	○
28	2	○
30	1	○
30	1,5	○
30	2	○
32	1	○
32	1,5	○
32	2	○
33	2	○
35	1,5	○
35	2	○
36	1,5	○
36	2	○
36	3	○
38	1,5	○
39	2	○
40	1,5	○
40	2	○
40	3	○
42	1,5	○
42	2	○
42	3	○
45	1,5	○
45	2	○
45	3	○
48	1,5	○
48	2	○
48	3	○
50	1,5	○
50	2	○
50	3	○

Confezione / Box / Colis:
M3 – M10: 10 pezzi / pcs
M12 – M16: 5 pezzi / pcs

€ Pag. listino - Price list - Liste des prix

108

● Standard

○ Disponibilità da richiedere, prezzo a listino
On enquiry, standard price-list / Stock à vérifier

★ Solo a richiesta
Only on request / Sur demande